

Panasonic[®]



Installation Guide DECT Cell Station Unit (SIP)

Model No. **KX-UDS124**

Thank you for purchasing this Panasonic product.
Please read this manual carefully before using this product and save this manual for future use.

KX-UDS124: Software File Version 01.300 or later

Table of Contents

- 1 For Your Safety3**
- 2 Overview9**
- 3 Installing the SIP Cell Stations16**
 - 3.1 Overview of SIP Cell Stations16
 - 3.2 Connecting SIP Cell Stations18
 - 3.3 Wall Mounting20
- 4 Deployment Procedure22**
 - 4.1 Overview22
 - 4.2 Site Planning25
 - 4.3 Site Survey31
 - 4.4 Example of How to Conduct the Site Survey40
 - 4.5 Example of How to Make a Site Map41
 - 4.6 Basic Network Configuration42
 - 4.7 CS Registration46
 - 4.8 Tree Survey49
 - 4.9 Configuration and PS Registration (for a system using a KX-NS1000)51
 - 4.9.1 Programming using Web Maintenance Console51
 - 4.9.2 Programming using the Web User Interface56
 - 4.9.3 Registering S-PSs to the Super Master CS57
 - 4.9.4 Programming PS Ring Group58
 - 4.10 Configuration and PS Registration (for a system using a third party SIP server)65
 - 4.10.1 Programming SIP-CSs for a Third Party SIP Server65
 - 4.10.2 PS Registration66
 - 4.11 How to back up and restore configuration data72
 - 4.12 PS Area Check73
- 5 Troubleshooting75**
- 6 Appendix77**
 - 6.1 Specifications77

1 For Your Safety

To prevent personal injury and/or damage to property, be sure to observe the following safety precautions.

The following symbols classify and describe the level of hazard and injury caused when this DECT Cell Station Unit (SIP) (SIP-CS) is operated or handled improperly.



This notice means that misuse could result in death or serious injury.



This notice means that misuse could result in injury or damage to property.

The following types of symbols are used to classify and describe the type of instructions to be observed.



This symbol is used to alert users to a specific operating procedure that must not be performed.



This symbol is used to alert users to a specific operating procedure that must be followed in order to operate the SIP-CS safely.



- Do not connect or disconnect the AC plug with wet hands.
- Do not touch the SIP-CS, AC adaptor or AC adaptor cord during a lightning storm.
- Do not allow anything to rest on the AC adaptor cord or LAN cable. Do not locate the SIP-CS where the AC adaptor cord or LAN cable may be stepped on or tripped on.
- When installing or testing a SIP-CS with an external AC adaptor, the AC adaptor should be plugged into a wall outlet or floor-mounted AC outlet. Do not connect the AC adaptor to a ceiling-mounted AC outlet, as the weight of the adaptor may cause it to become disconnected.
- Make sure that you do not short the battery or cables.
- Never attempt to insert wires, pins, etc. into the vents or other holes of the SIP-CS.
- Do not splash water on the AC adaptor or the power cord, nor get them wet. Doing so can result in fire, electric shock, or injury. If they do get wet, immediately disconnect the AC adaptor and power cord, and contact an authorised service centre.
- Do not touch the AC adaptor for extended periods of time. Doing so can lead to low-degree burns.
- Do not make power connections that exceed the ratings for the AC outlet or power equipment. If the power rating of a surge protector, etc. is exceeded, it can cause a fire due to heat buildup.
- Care should be taken so that objects do not fall onto, and liquids are not spilled into, the SIP-CS. Do not subject the SIP-CS to excessive smoke, dust, moisture, mechanical vibration, shock, or direct sunlight.
- Do not place heavy objects on top of the SIP-CS.
- Do not mount the SIP-CS in a manner other than that described in this manual.



- The SIP-CS must only be installed and serviced by qualified service personnel. The SIP-CS should be used as-is from the time of purchase; it should not be disassembled or modified. Disassembly or modification can cause a fire, electric shock, or damage to the SIP-CS.
- Make sure that the wall that the SIP-CS will be attached to is strong enough to support the SIP-CS (approx. 290 g). If not, it is necessary for the wall to be reinforced.
- Only use the wall-mounting equipment (screws, washers) included with the SIP-CS.
- When the SIP-CS is no longer in use, make sure to detach it from the wall.
- Disconnect the SIP-CS from the AC outlet, disconnect the LAN cable, and contact the dealer if:
 - The AC adaptor cord or AC plug becomes damaged or frayed.
 - The SIP-CS is exposed to rain, water, or any other liquid.
 - The SIP-CS is dropped or damaged.
 - Internal components are exposed due to damage.
 - The SIP-CS does not operate properly.
 - Performance deteriorates.
- Disconnect the SIP-CS from the AC outlet and disconnect the LAN cable if the SIP-CS emits smoke, an abnormal smell, or makes unusual noise. These conditions can cause fire or electric shock. Confirm that smoke has stopped and contact an authorised service centre.
- Clean the AC plug periodically with a soft, dry cloth to remove dust and other debris.
- If using an AC adaptor, use only the optional AC adaptor KX-A239CE (PQLV206CE), KX-A239UK (PQLV206E), KX-A239BX (PQLV206CE), KX-A239EJ (PQLV206E), or KX-A239AL (PQLV206AL).
- If damage to the SIP-CS exposes any internal parts, immediately disconnect the cable or cord. If the power is supplied from the network to the SIP-CS (Power-over-Ethernet), disconnect the Ethernet cables. Otherwise, disconnect the AC adaptor cord. Then return the SIP-CS to a service centre.
- The SIP-CS should only be connected to a power supply of the type shown on the label on the SIP-CS.
- Completely insert the AC adaptor/power plug into the AC outlet. Failure to do so may cause electric shock and/or excessive heat resulting in a fire.



CAUTION



- Do not stretch or bend the cables. Also, do not allow anything to rest on the cables.
- Do not bundle cables that are connected to the SIP-CS with the AC power cords of machines located nearby.
- To prevent malfunction, deformity, overheating, rust, and discolouration, do not install or place equipment in the following types of locations:
 - Locations where air ventilation is poor.
 - Locations that may be exposed to sulphurous gas, such as near hot springs.
 - Near devices that emit heat, such as heaters.
 - Near devices that emit electromagnetic noise, such as radios or televisions.
 - Near devices that emit high-frequency noise, such as sewing machines or welders.
- The SIP-CS and the cables should never be placed near or over a radiator or other heat source.
- The SIP-CS should not be placed outdoors (use indoors).

- The SIP-CS should not be placed near high-voltage equipment.
- The SIP-CS should not be placed on a metal object.



- The SIP-CS should be kept free of dust, moisture, high temperature (more than 40 °C), low temperature (less than 0 °C), and vibration, and should not be exposed to direct sunlight.
- When driving the screws into the wall, be careful to avoid touching any metal laths, wire laths or metal plates in the wall.
- Use cables that are fire-resistant or fireproof.
- Make sure the cables are securely fastened to the wall.
- The AC adaptor is used as the main disconnect device. Ensure that the AC adaptor is located near the SIP-CS and is easily accessible.
- Disconnect the AC adaptor cord and all cables from the SIP-CS before cleaning. Clean the SIP-CS with a soft, dry cloth. Do not use liquid, aerosol cleaners, abrasive powders, or chemical agents to clean the SIP-CS.
- When left unused for a long period of time, disconnect the SIP-CS from the AC outlet. When the SIP-CS receives power from a PoE power supply, disconnect the LAN cable.
- **Medical**—consult the manufacturer of any personal medical devices, such as pacemakers, to determine if they are adequately shielded from external RF (radio frequency) energy. (The SIP-CS operates in the frequency range of 1880 MHz to 1900 MHz, and the output peak power level is less than 0.25 W.) Do not use the SIP-CS in health care facilities if any regulations posted in the area instruct you not to do so. Hospitals or health care facilities may be using equipment that could be sensitive to external RF (radio frequency) energy.
- To ensure the security of private conversations, only connect the SIP-CS to a secure network.
- To prevent unauthorised access, only connect the SIP-CS to a network that is properly managed.
- Make sure all personal computers that are connected to the SIP-CS employ up-to-date security measures.
- To avoid unauthorised access and possible abuse of your phone system, we strongly recommend:
 - Keeping the password secret.
 - Changing your password regularly.
 - Selecting a complex, random password that cannot be easily guessed.
- Maintain the distances listed in "Required Distances between Equipment" between equipment in order to prevent noise, interference or the disconnection of a conversation. (The distance may vary depending on the environment.)

Notice

SAFETY REQUIREMENTS

- Before connecting the SIP-CS, confirm that the SIP-CS supports the intended operating environment.
- If the SIP-CS does not operate properly, disconnect the AC adaptor cord and LAN cable, then connect again.
- The SIP-CS may not operate in the event of a power failure.
- Do not move the SIP-CS while it is in use.
- Satisfactory operation, interoperability, and compatibility cannot be guaranteed with all equipment connected to the SIP-CS, nor with all services provided by telecommunications providers over networks connected to the SIP-CS.

SECURITY REQUIREMENTS

- Privacy of communications may not be ensured when using the wireless systems.
- Keep a copy of all important data (such as your network information) before sending the machine for repair.

1 For Your Safety

- The SIP-CS can store your private/confidential information. To protect your privacy/confidentiality, we recommend that you initialise the SIP-CS to erase all user data and restore the factory default settings before you dispose, transfer or return the SIP-CS.

Note

In this manual, the suffix of each model number (e.g., KX-UDS124**CE**) is omitted unless necessary.

Additional Information

For users in the European Union only

Information for Users on Collection and Disposal of Old Equipment and used Batteries



These symbols on the products, packaging, and/or accompanying documents mean that used electrical and electronic products and batteries should not be mixed with general household waste.

For proper treatment, recovery and recycling of old products and used batteries, please take them to applicable collection points, in accordance with your national legislation and the Directives 2002/96/EC and 2006/66/EC.

By disposing of these products and batteries correctly, you will help to save valuable resources and prevent any potential negative effects on human health and the environment which could otherwise arise from inappropriate waste handling.

For more information about collection and recycling of old products and batteries, please contact your local municipality, your waste disposal service or the point of sale where you purchased the items.

Penalties may be applicable for incorrect disposal of this waste, in accordance with national legislation.

For business users in the European Union

If you wish to discard electrical and electronic equipment, please contact your dealer or supplier for further information.



Information on Disposal in other Countries outside the European Union

These symbols are only valid in the European Union. If you wish to discard these items, please contact your local authorities or dealer and ask for the correct method of disposal.



Cd

Note for the battery symbol (bottom two symbol examples):

This symbol might be used in combination with a chemical symbol. In this case it complies with the requirement set by the Directive for the chemical involved.

Notes

- The screen shots shown in this guide are provided for reference only, and may differ from the screens displayed on your PC.
- The contents and design of the software are subject to change without notice.

For users in Singapore only

Complies with
IDA Standards
DB 01017

For users in Hong Kong only



2 Overview

Outline

This document describes the installation, deployment, configuration of a SIP-based DECT system that works with a KX-NS1000 Panasonic Pure IP-PBX or a third party SIP server. In this system, SIP-based DECT Portable Stations are used together with SIP-CSs.

Related Documentation

Administrator Guide

Describes the programming and maintenance of the SIP-CS.

Please refer to the following web site for more information:

<http://panasonic.net/pcc/support/sipphone>

Terminology

Air Sync Group

Air Synchronisation Group

To obtain steady air synchronisation over a wide area, it is necessary to create Air Sync Groups.

Air Sync Master CS

Primary Clock Master of an Air Sync Group

Each Air Sync Group must have a unique Air Sync Master.

Air Sync Secondary Master CS

Secondary Clock Master of an Air Sync Group

DECT

Digital Enhanced Cordless Telecommunication

Handover

Allows you to move between CS coverage areas during a conversation without disrupting the call. This is only possible within the same Air Sync Group.

ICD

Incoming Call Distribution

ICD Group

An incoming call distribution group receives calls directed to the group. Incoming calls directed to an incoming call distribution group are distributed to the member extensions in the group.

IPEI

International Portable Equipment Identity

Decimal, 12-digit, globally unique identification code of PSs. Specified in ETSI EN 300 175-6.

Primary CS

Primary CS for air synchronisation

PS Ring Group

A PS ring group is a group of PS extensions that receives incoming calls. Each group has a floating extension number and name. One PS can belong to multiple groups.

Roaming

Allows you to move between coverage areas of SIP-CSs (even inter-Air Sync Group or Inter-SIP Server) when the S-PS is idle.

S-PS

SIP-CS compatible Portable Station/Handset

Secondary CS

Secondary CS for air synchronisation

SIP-CS

SIP Cell Station

Super Master CS

Master CS of Air Sync Group 1

This CS manages configuration for the whole system.

Tree Survey

The procedure to obtain a steady air synchronisation tree.

Web Maintenance Console

Used for system programming, diagnosis and administration of the KX-NS1000 via PCs. Web Maintenance Console is accessed through a Web browser running on a networked PC.

System Overview

The SIP-CS can be connected to a SIP server via a LAN and supports S-PSs for making calls. The SIP-CS allows for easy and cost-saving installation using an existing IP network infrastructure. Air synchronisation technology is used for synchronising each SIP-CS.

The SIP-CS provides the following:

- Wireless systems using a converged voice and data network infrastructure.
- Wireless branch offices and wireless solutions by long distance installation on larger premises when located on the same network.
- Reliable wireless communication using DECT technology over an IP network.
- High quality voice communication.
- Easy maintenance using wireless download.

The following is an example of SIP-CS installation using an IP network.

To obtain steady air synchronisation, create two or more Air Sync Groups to cover a wide area, as shown below.

 : Handover is working.

Roaming (Inter Air Sync Group)

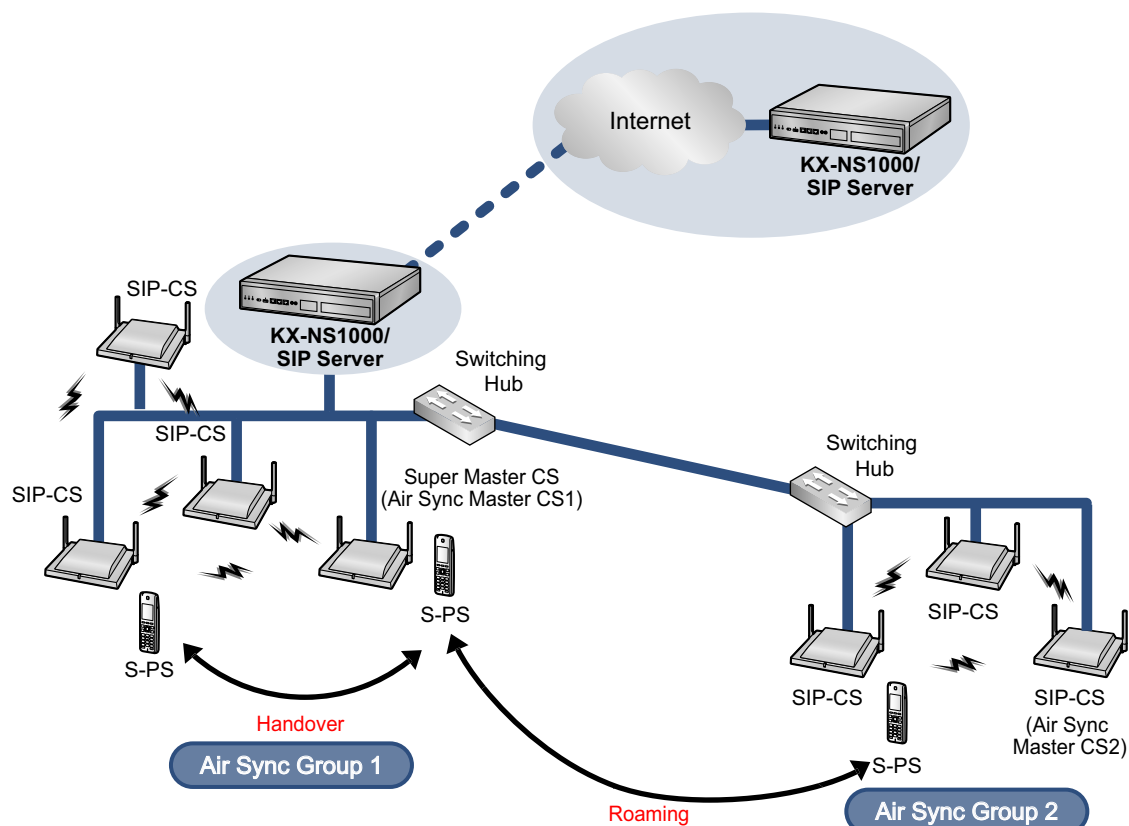
**Note**

- You can move between the coverage areas of SIP-CSs during a conversation, without disrupting the call. This is called "Handover" and is only possible within the same Air Sync Group. You cannot move between Air Sync Groups during a conversation. You can only move between Air Sync Groups when in idle status. This is called "Roaming".
- Each Air Sync Group requires an Air Sync Master CS.
- The system requires one Super Master CS to control the system as a whole. The Air Sync Master CS of Air Sync Group 1 becomes the Super Master CS.
- All SIP-CSs of the same model consist of the same hardware and same firmware, but each SIP-CS's role (Master/Slave) is decided by its settings.

Roaming (Inter SIP Server)

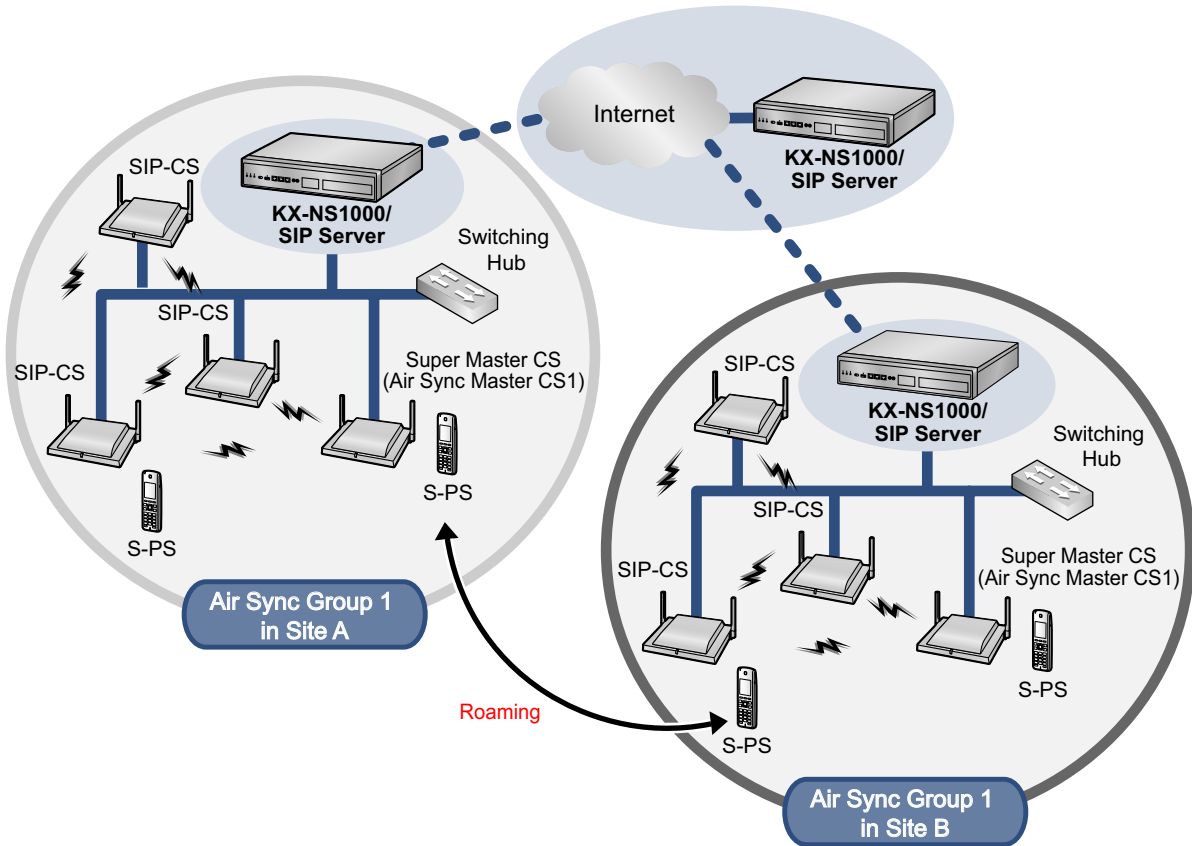

Note

- You can use an S-PS in other systems (sites), if you register it to each system beforehand. You can register an S-PS to up to 4 systems.
- Air Sync Groups at different sites connected by a dedicated line (such as an IP-VPN), which share a Super Master CS and a SIP Server, are considered part of the same system.

SIP Signalling and Media Stream Control Overview

Moving while in standby mode

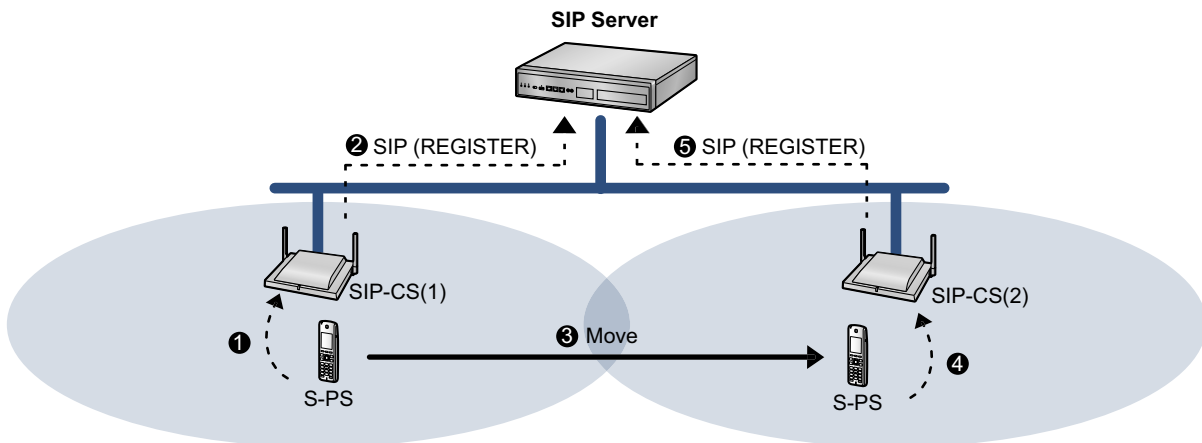

- ❶ The S-PS requests Location Registration from SIP-CS(1).
- ❷ SIP-CS(1) requests SIP Registration from the SIP server.
- ❸ The S-PS moves from coverage area of SIP-CS(1) to the coverage area of SIP-CS(2).
- ❹ The S-PS requests Location Registration from SIP-CS(2).
- ❺ SIP-CS(2) requests SIP Registration from the SIP server.

SIP registration is executed each time the S-PS performs location registration while it is idle.

Moving while talking

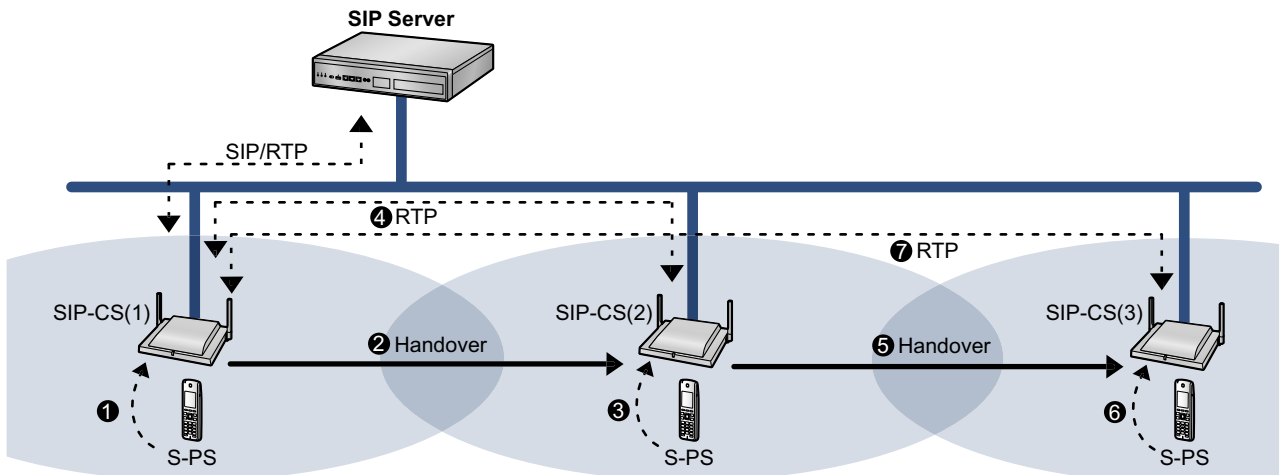

- ❶ The S-PS requests Location Registration to SIP-CS(1), and then the S-PS starts the call.
- ❷ The S-PS moves from the coverage area of SIP-CS(1) to the coverage area of SIP-CS(2).
- ❸ The S-PS requests Location Registration to the SIP-CS(2).
- ❹ RTP is transferred from SIP-CS(1) to SIP-CS(2).
- ❺ The S-PS moves from the coverage area of SIP-CS(2) to the coverage area of SIP-CS(3).
- ❻ The S-PS requests Location Registration to the SIP-CS(3).
- ❼ RTP is transferred from SIP-CS(1) to SIP-CS(3).

SIP signalling and the media stream are sent between the SIP-CS currently in use and the SIP-CS that was being used when the call started.

System Configuration

The Air Sync Master CS of Air Sync Group 1 is the most important SIP-CS. It is called the Super Master CS. The Super Master CS has the following roles:

- Portal for all settings.
- Management of the synchronisation tree of all SIP-CSs.
- Distribution of configuration data via Web user interface programming or configuration file programming.
- Distribution of SIP-CS and S-PS firmware data to all SIP-CSs in the system.
- Distribution of imported phonebook data to all SIP-CSs in the system.

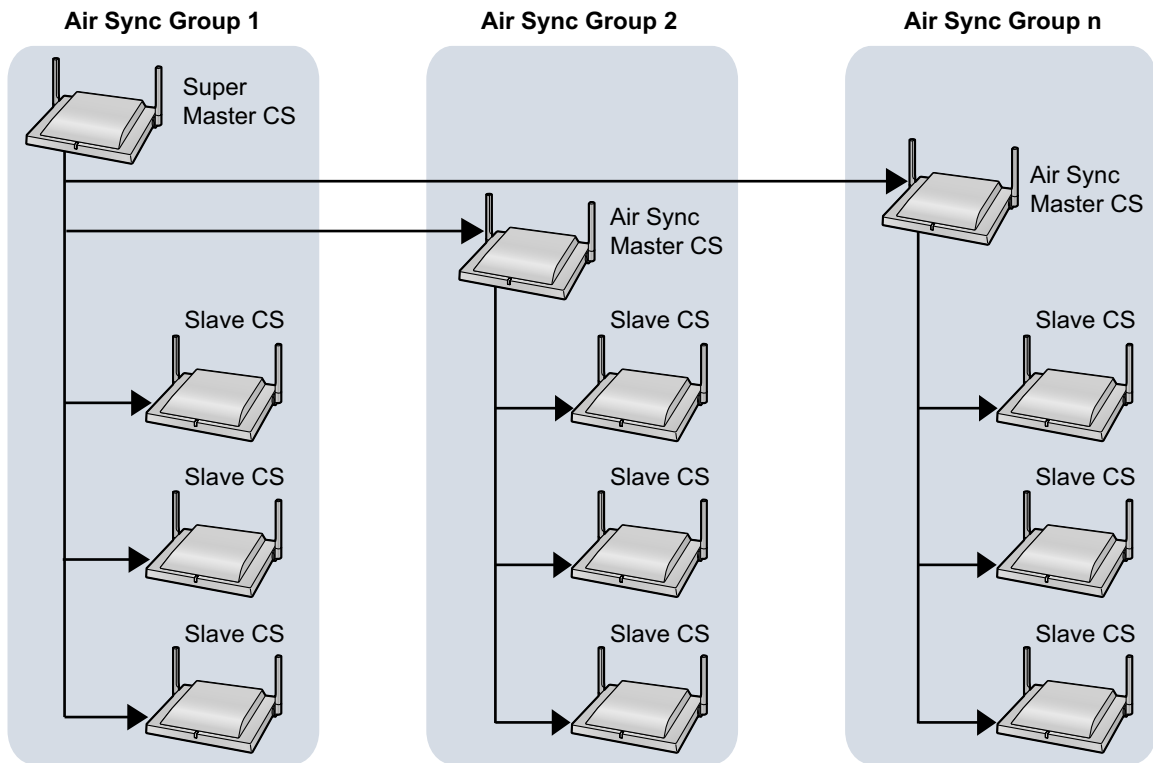

Data flow of SIP-CSs

1. The Super Master CS distributes data to each Air Sync Master CS.
2. Each Air Sync Master CS distributes the data to all Slave CSs in the Air Sync Group. Also, the Super Master CS distributes the data to all Slave CSs in Air Sync Group 1.

Note

- Data will be distributed until all Slave CSs in all Air Sync Groups receive the data.
- Data is distributed in the following situations:
 - When the Super Master CS is started.
 - When **All Save** is performed through the Web user interface.
 - When Timed forwarding update is set.
 - When Timed phonebook importing is set.

System Specifications

Specifications when connecting to a third party SIP server are as follows.

Item	Maximum Number per System
S-PS	255
SIP-CS	128 (32 SIP-CSs per Air Sync Group)
Air Sync Group	8

Note

An S-PS can be registered to up to 4 systems.

For specifications when connecting to a KX-NS1000, refer to the Installation Manual of the KX-NS1000.

3 Installing the SIP Cell Stations

3.1 Overview of SIP Cell Stations

Names and Locations

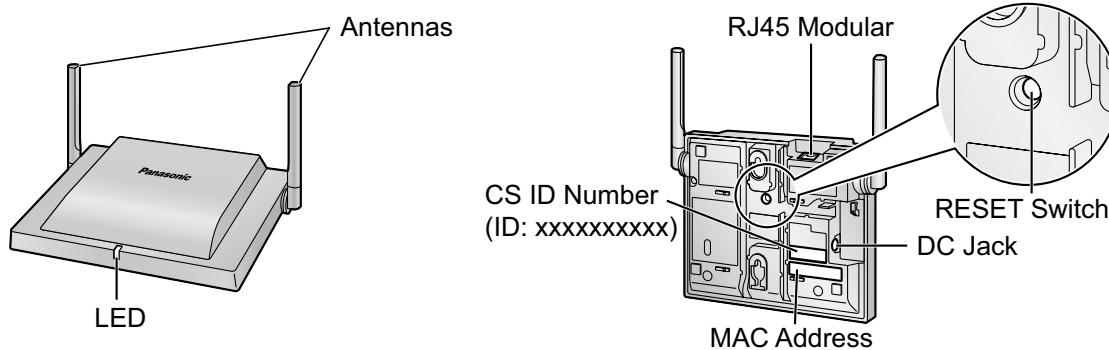

Unpacking

Unpack the box and check the items below:

SIP Cell Station	1
Screws	2
Washers	2

LED Indications

SIP-CS State	Description
General Operation	<ul style="list-style-type: none"> • OFF: Power Off/SIP-CS Software downloading • Green ON: Stand-by (no active calls) • Slow green flashing: Talk (active calls) / S-PS data transfer² • Moderate green flashing: Busy¹ • Red ON: Fault • Slow red flashing: Out of Service/Starting up (data link establishment → air synchronisation) • Moderate red flashing: Starting up (power on → data link establishment) • Amber ON: Stand-by (unstable synchronisation [no active calls]) • Slow amber flashing: Talk (unstable synchronisation [active calls]) / S-PS data transfer² (unstable synchronisation) • Moderate amber flashing: Busy¹ (unstable synchronisation) <p>Note</p> <p>LED flashing patterns are as follows:</p> <ul style="list-style-type: none"> • Slow Flashing: 60 times per minute • Moderate Flashing: 120 times per minute

¹ All voice channels are occupied.

² S-PS software downloading, S-PS phonebook transferring, etc.

3.2 Connecting SIP Cell Stations

Connecting a SIP-CS to a LAN

Notice

- Connect the SIP-CSs to the LAN only after completing network settings. For details about network settings, see "Configuring Network Settings for Air Sync Master CS" in "4.3 Site Survey".
- When connecting a SIP-CS to the LAN, connect it to a switching hub.

Note

- Use an Ethernet straight cable with an RJ45 connector to connect the SIP-CS to a switching hub. The cable should be a 10BASE-T/100BASE-TX CAT 5 (Category 5) or higher cable, and the diameter of the cable must be 6.5 mm or less.
- It is possible to connect the SIP-CS to the LAN while registering the SIP-CS to the SIP server.

1. Connect the cable to the SIP-CS.

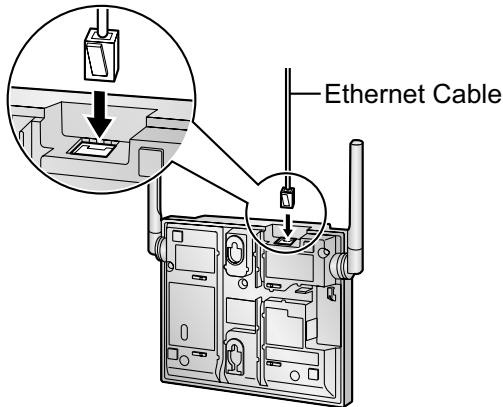

2. Pass the cable through the groove of the SIP-CS in one of the following three ways.

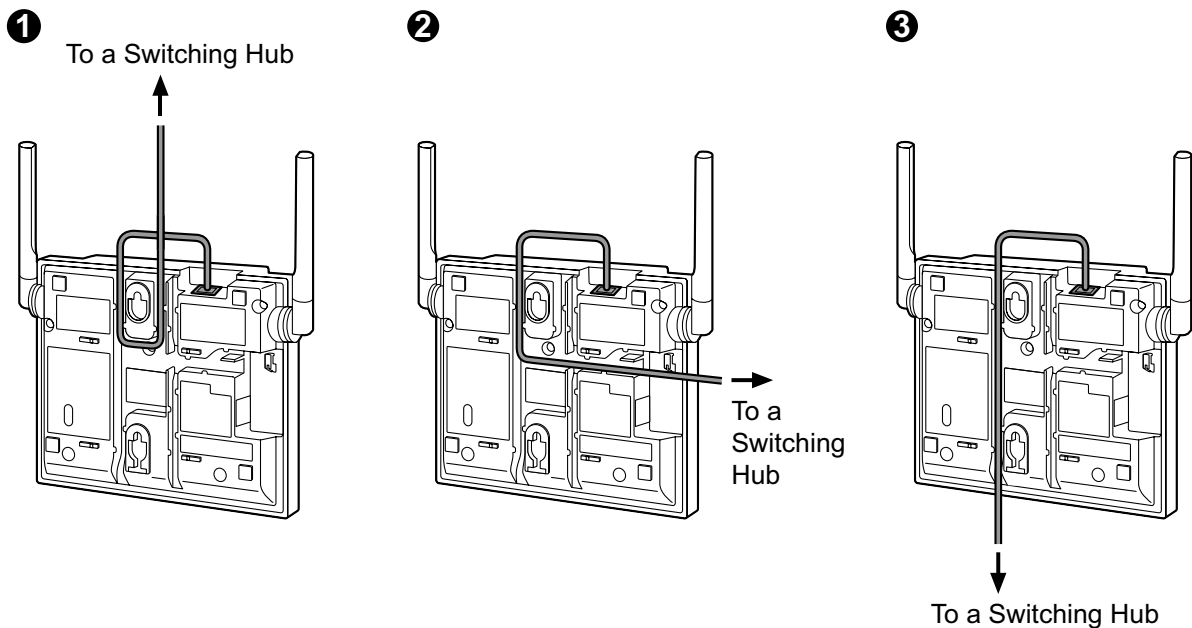

3. Connect the other end of the cable to the switching hub.

Connecting an AC Adaptor to a SIP-CS

SIP-CSs comply with the IEEE 802.3af Power-over-Ethernet (PoE) standard. If PoE is available on your network, these SIP-CSs can receive the necessary power supply from the network through the network cable. In this case, no AC adaptor is needed for the SIP-CSs.

However, if PoE is not available, you will need to connect an AC adaptor to the SIP-CS.

WARNING

When installing or testing a SIP-CS with an external AC adaptor, the AC adaptor should be plugged into a wall outlet or floor-mounted AC outlet. Do not connect the AC adaptor to a ceiling-mounted AC outlet, as the weight of the adaptor may cause it to become disconnected.

Note

Use only the optional AC adaptor KX-A239 for the SIP-CS. For details about the optional AC adaptor, refer to "AC Adaptor" in "6 Appendix".

1. Connect the AC adaptor cord to the SIP-CS.

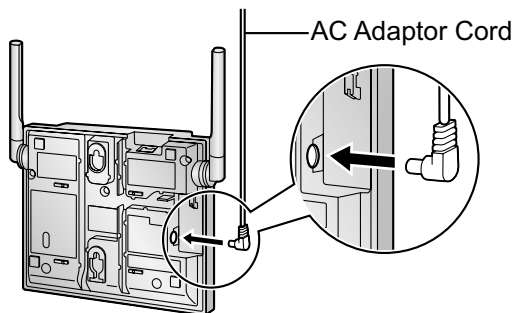

2. Pass the cord through the groove of the SIP-CS in one of the following three ways.

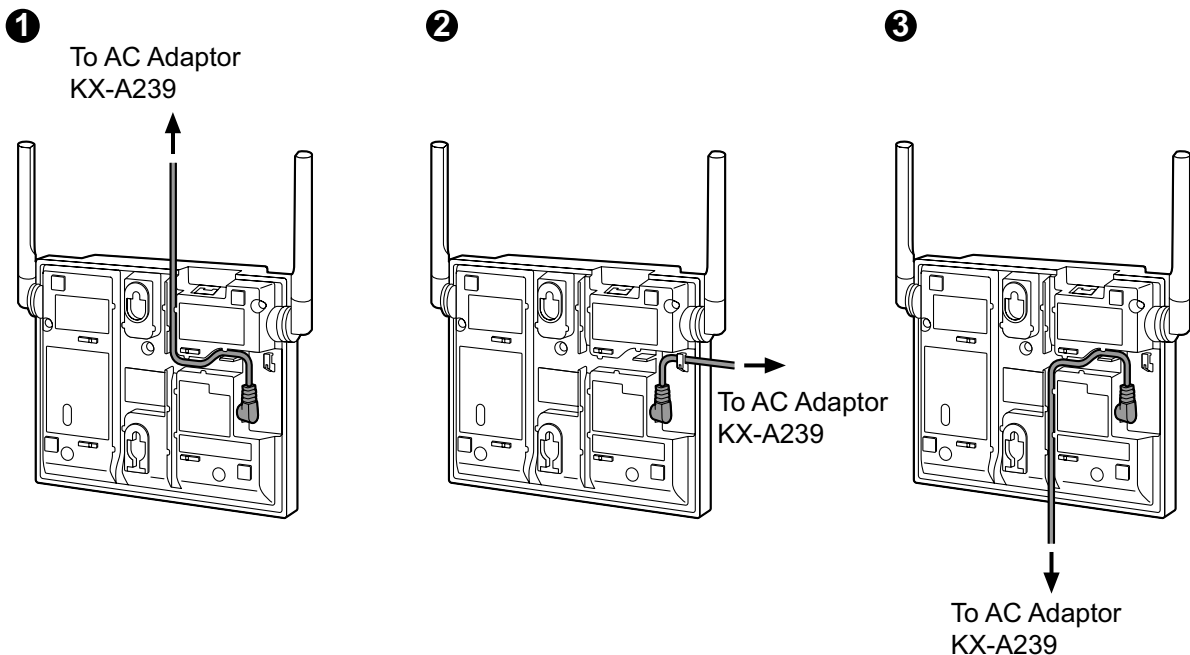

3. Connect the AC adaptor to an AC outlet.

3.3 Wall Mounting

Mounting

WARNING

- Make sure that the wall that the SIP-CS will be attached to is strong enough to support the SIP-CS (approx. 290 g). If not, it is necessary for the wall to be reinforced.
- Only use the wall-mounting equipment (screws, washers) included with the SIP-CS.
- When the SIP-CS is no longer in use, make sure to detach it from the wall.

CAUTION

- When driving the screws into the wall, be careful to avoid touching any metal laths, wire laths or metal plates in the wall.
- Do not stretch or bend the cables. Also, do not allow anything to rest on the cables.
- Use cables that are fire-resistant or fireproof.
- The SIP-CS and the cables should never be placed near or over a radiator or other heat source.
- Do not bundle cables that are connected to the SIP-CS with the AC power cords of machines located nearby.
- Make sure the cables are securely fastened to the wall.

Notice

Panasonic assumes no responsibility for injuries or property damage resulting from failures arising out of improper installation or operation inconsistent with this documentation.

1. Place the reference for wall mounting on the wall to mark the 2 screw positions.
2. Install the 2 screws and washers (included) into the wall.

Note

- Make sure that the screw heads are at the same distance from the wall.
 - Install the screws perpendicular to the wall.
3. Hook the SIP-CS on the screw heads.

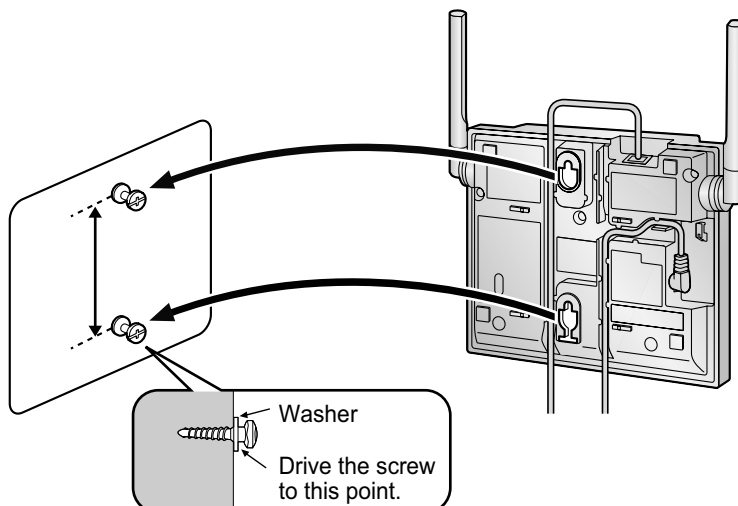

4. Position the antennas according to the following illustration so that they are pointing in directions that are 90 degrees apart (for antenna diversity).

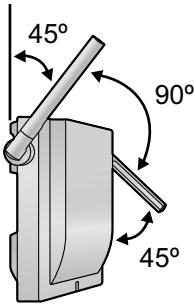

Reference for Wall Mounting

Please copy this page and use as a reference for wall mounting.

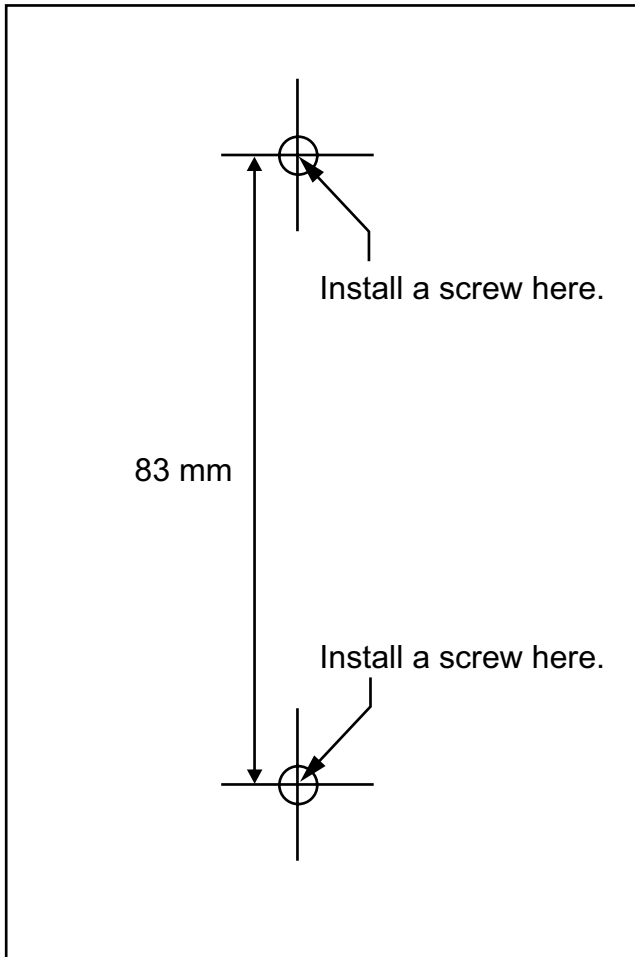

Note

Make sure to set the print size to correspond with the size of this page. If the dimension of the paper output still deviates slightly from the measurement indicated here, use the measurement indicated here.

4 Deployment Procedure

The deployment procedure for establishing a wireless system is as follows.

Note

The deployment procedures of "5. Configuration" and "6. S-PS Registration" in "4.1 Overview" differ from each other depending on the SIP server (KX-NS1000 or third party SIP server) used in the system.

Conditions for Configuring the Air Synchronisation

Notice

For General Networking

- A static IP address is required for the Super Master CS.

For Wireless Networking

- Do not locate SIP-CS belonging to different air synchronisation groups in the same area.
- The SIP-CS assigned as the Super Master CS or the Master CS for each air synchronisation group should be located in the three dimensional centre of the installation site.
- Radio signals from other wireless devices can affect Air synchronisation and communication between SIP-CSs and S-PSs.

Required Distances between Equipment

CAUTION

Maintain the distances listed below between equipment in order to prevent noise, interference or the disconnection of a conversation. (The distance may vary depending on the environment.)

Equipment	Distance
SIP-CS and office equipment such as a computer, telex, fax machine, etc.	More than 2 m
SIP server and SIP-CS	More than 2 m
SIP-CS and other radio device	More than 5 m

Notice

If multiple SIP-CSs provide service in the same area, the phone connection may become noisy or the number of possible simultaneous calls with S-PSs may decrease due to interference between the SIP-CSs. The required distance between SIP-CSs may vary depending on the environment of the installation site and conditions in which the wireless system is used. Conduct a site survey to determine the appropriate distance.

4.1 Overview

1. Site Planning

Choose the optimal installation locations for SIP-CSs. Site planning requires careful preparation and thorough testing.

2. Site Survey

Confirm the signal condition of the planned location using two un-registered CSs and one S-PS.

When connecting the wireless system, use extreme care in conducting the site survey. Site surveys can be conducted using two KX-UDS124s. An incorrectly performed site survey can result in a poor service area, frequent noise, disconnection of calls, and synchronisation failure of SIP-CSs.

3. CS Registration

Register all SIP-CSs in the system which the Air Sync Master CS is controlling.

4. Tree Survey

Create the synchronisation hierarchy for each Air Sync Group to provide stable air synchronisation. There are 2 types of Tree Survey methods, as shown in the table below:

Tree Survey Type	Description	References
Web User Interface Programming	Installing the SIP-CS after conducting a Tree Survey by accessing the Web user interface from a PC connected to the same network. This method provides an easier but less accurate Tree Survey.	Refer to "4.8 Tree Survey"
CS Maintenance Tool Programming	Installing the SIP-CS after conducting a Tree Survey using the CS Maintenance Tool installed on a PC connected to the same network. This method provides a more accurate Tree Survey.	Refer to the "SIP-CS Maintenance Tool Guide for DECT SIP Cell Station Unit" on the following web site for more information: http://panasonic.net/pcc/support/sipphone

Notice

If the Tree Survey is going to be conducted for 10 or more SIP-CSs, use the CS Maintenance Tool.

5. Configuration

Specify SIP server network information and SIP account information for extensions.

Note

This procedure differs depending on the SIP server used in the system.

- When using a KX-NS1000, see "4.9 Configuration and PS Registration (for a system using a KX-NS1000)".
- When using a third party SIP server, see "4.10 Configuration and PS Registration (for a system using a third party SIP server)".

6. S-PS Registration

Register S-PSs to the SIP-CSs.

Note

This procedure differs depending on the SIP server used in the system.

- When using a KX-NS1000, see "4.9 Configuration and PS Registration (for a system using a KX-NS1000)".
- When using a third party SIP server, see "4.10 Configuration and PS Registration (for a system using a third party SIP server)".

7. S-PSs Area Check

Check the service area, sound quality, and handover operation under actual conditions.

4.2 Site Planning

In order to be able to move between coverage areas during a call (Handover), synchronisation between SIP-CSs is necessary. If synchronisation between SIP-CSs has not been configured, handover will fail. The source of synchronisation is called a Master CS and the target of synchronisation is called a Slave CS. An Air Sync Group is created with the Master/Slave CSs on different levels. The source of synchronisation for each SIP-CS in an Air Sync Group is called an Air Synchronisation Master CS.

The number of Master/Slave levels in an Air Sync Group cannot exceed 8. To ensure that the number of levels does not exceed 8, locate the Air Synchronisation Master CS in the centre of the group. A greater number of levels can lead to instability in handover and air synchronisation.

The Master CS of Air Sync Group 1 is called the Super Master CS and controls the whole system.

CS Coverage Area for Air Synchronisation between SIP-CSs

The example below shows the size of the area where one SIP-CS can synchronise with other SIP-CSs, if it is installed in an area with no obstacles.

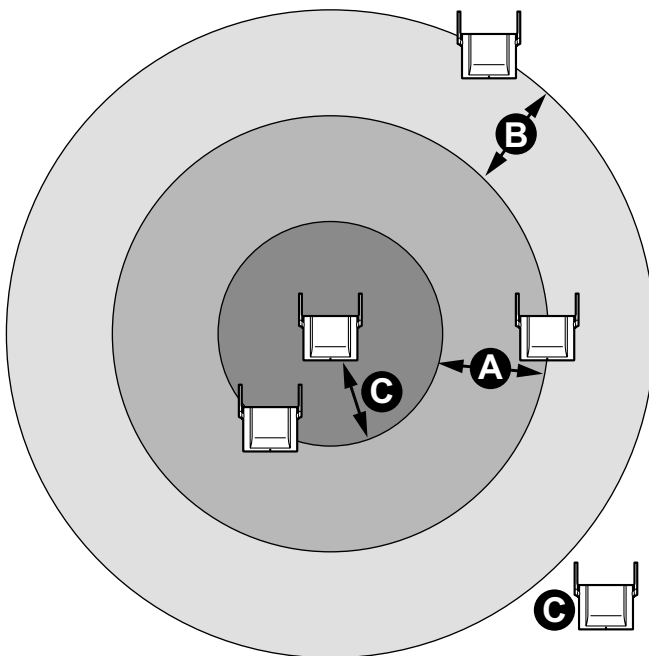

Area	Description
A	Very Good Coverage Area: Radio signal strength level is "Very Good" (1 m to 40 m). Good synchronisation quality can be maintained.
B	Good Coverage Area Radio signal strength level is "Good" (about 40 m to 50 m).
C	Out of Service: Too close (0 m to 1 m) or too far so that the radio signal is lost and the SIP-CSs cannot be synchronised.

Note

For air synchronisation radio signal strength details, refer to "Site Survey Mode" in the "LED Indications" table found in "3.1 Overview of SIP Cell Stations".

Good Example:

The Master CS is located in the centre of the installation site for each Air Sync Group.

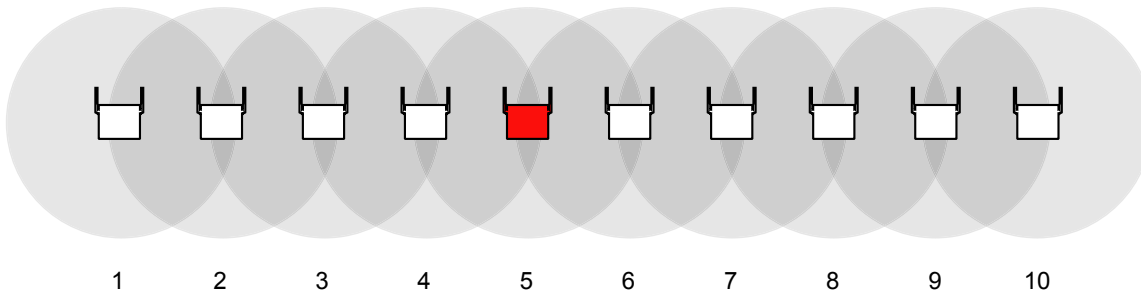

Number of Master/Slave level: 5

Bad Example:

The Master CS is **NOT** located in the centre of the installation site for each Air Sync Group. Therefore, the number of layers in the hierarchy exceeds 8.

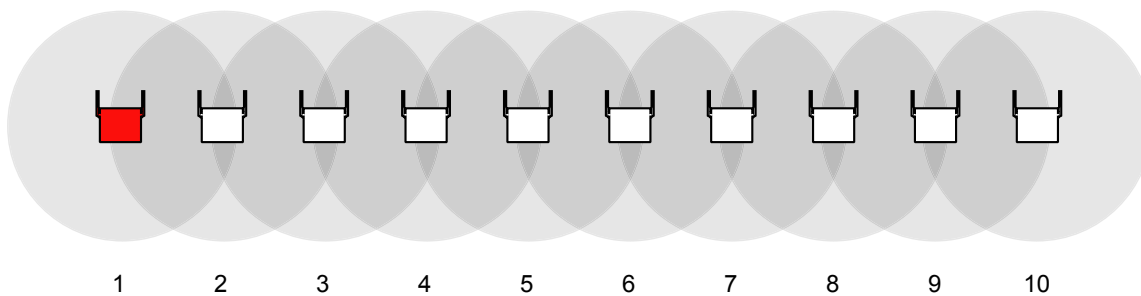

Number of Master/Slave level: 9

Notice

- Choosing the best site for the SIP-CS requires careful planning and testing. The best location may not always be convenient for installation.
- It is necessary to locate SIP-CSs within synchronisation range of other SIP-CSs, however, locating SIP-CSs too close to each other can lead to interference and a reduction in the number of simultaneous calls. In a regular office, the average distance between SIP-CSs should be approximately 30 m. However, since walls, metallic shelves, etc. can weaken signals, air synchronisation may not be as stable as planned. Conduct a site survey after installing the SIP-CSs, as described in "4.3 Site Survey".

Understanding Radio Waves

Characteristics of Radio Waves

The transmission of radio waves and the SIP-CS coverage area depend on the structure and materials of the building.

Office equipment, such as computers and fax machines, can interfere with radio waves. Such equipment may create noise or interfere with the performance of the S-PS.

The illustration below shows the special transmitting patterns of radio waves.

1. Radio waves are reflected by objects made of materials such as metal.
2. Radio waves are diffracted by objects such as metallic columns.
3. Radio waves penetrate objects made of materials such as glass.

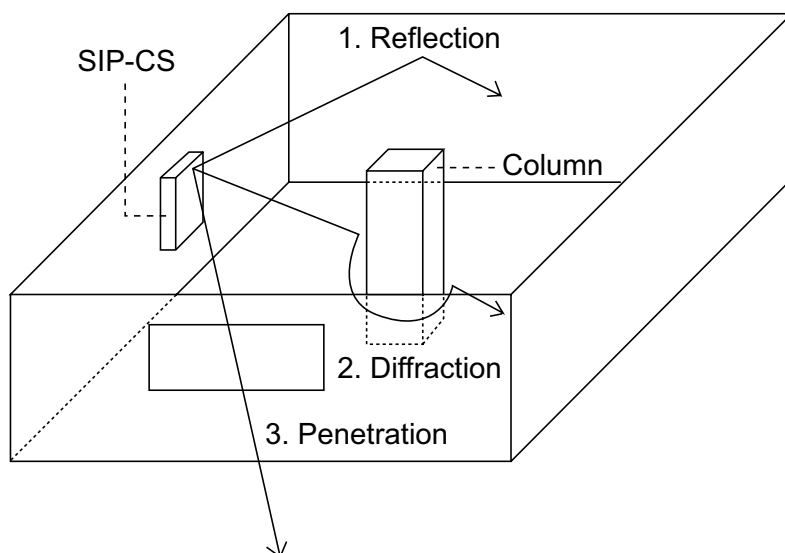

Relationships Between Radio Waves and Building Structure and Materials

- The SIP-CS coverage area is affected more by the building materials and their thickness than the number of obstacles.
- Radio waves tend to be reflected or diffracted by conductive objects and rarely penetrate them.
- Radio waves tend to penetrate insulated objects and are rarely reflected by them.
- Radio waves penetrate thin objects more than thick objects.
- The table below shows the transmission tendency of radio waves when they reach objects made from various materials.

Object	Material	Transmission Tendency
Wall	Concrete	The thicker they are, the less radio waves penetrate them.
	Ferroconcrete	Radio waves can penetrate them, but the more iron there is, the more radio waves are reflected.
Window	Glass	Radio waves usually penetrate them.
	Glass with wire net	Radio waves can penetrate them, but tend to be reflected.
	Glass covered with heat-resistant film	Radio waves are weakened considerably when they penetrate windows.
Floor	Ferroconcrete	Radio waves can penetrate them, but the more iron there is, the more radio waves are reflected.
Partition	Steel	Radio waves are reflected and rarely penetrate them.
	Plywood, Glass	Radio waves usually penetrate them.

Object	Material	Transmission Tendency
Column	Ferroconcrete	Radio waves can penetrate them, but the more iron there is, the more radio waves tend to be reflected or diffracted.
	Metal	Radio waves tend to be reflected or diffracted.
Cabinet	Steel	Radio waves are usually reflected or diffracted, and rarely penetrate them.
	Wood	Radio waves can penetrate them, but they are weakened.

General Installation

Obtain a map of the SIP-CS installation site, identify the service area required by the user on the map, and then plan the location of each SIP-CS.

It is recommended that you install the SIP-CS at a height of 2 m or more for less obstructions.

Follow the procedure below to perform site planning for general installation:

1. Decide where to install the first SIP-CS.
2. Install the second SIP-CS at a distance of about 30 m from the first SIP-CS. If you cannot maintain a distance of 30 m due to building limitations, install the second SIP-CS as far away as possible in the overlapping range of the air synchronisation coverage area.

Notice

Locate SIP-CSs so that places where most calls will be made are within the coverage area of as many SIP-CSs as possible.

3. When you have covered the necessary area, make the SIP-CS that is adjacent to most other SIP-CSs into the Air Sync Master CS.

Adjoining Installation

When you want to make many simultaneous calls in a small area, locate SIP-CSs according to the table below.

Simultaneous Calls	Number of CSs	Distance between CSs
Up to 4 ^{*1}	1	-
Up to 8 ^{*1}	2	1 m (Example 1)
Up to 12 ^{*1}	3	10 m (Example 2)
Up to 16 ^{*1}	4	10 m (Example 3)
More than 17	not recommended	not recommended

^{*1} Depending on radio conditions (e.g., interference from other systems), the maximum number of simultaneous calls may be reduced.

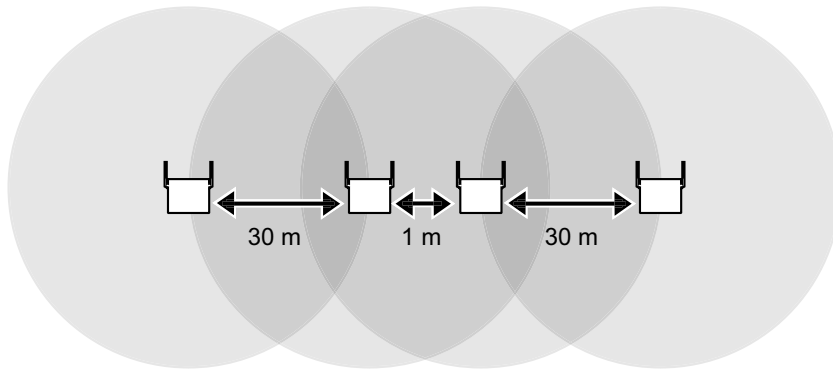
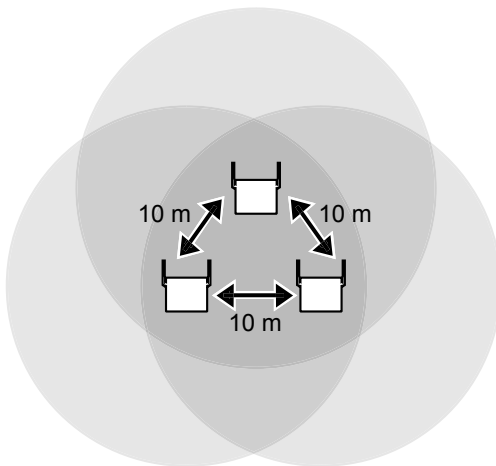
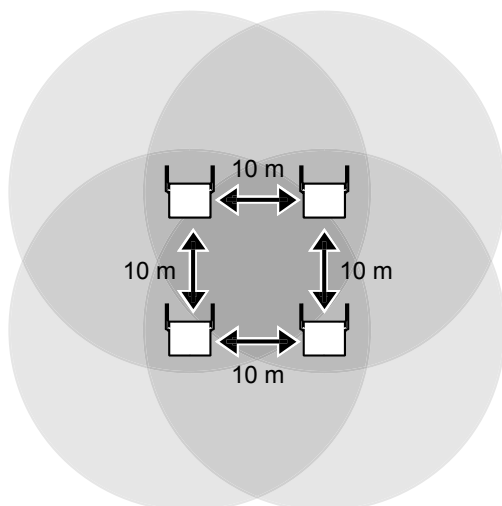
Example 1**Example 2****Example 3****Notice**

- It may not be possible to create an Air Sync Group that spans multiple floors, because the dividing ceilings may weaken the signal too much. In this case, locate a connecting SIP-CS in the staircase between each floor.

4 Deployment Procedure

- When creating an Air Sync Group that spans multiple floors, make sure that you conduct a site survey across the floors.
- Make the SIP-CS that is adjacent to most other SIP-CSs (in all 3 dimensions) into the Master CS.

Air Synchronisation

Air synchronisation assigns classifications to SIP-CS and establishes connections based on those classifications. This creates a robust system where the whole system is not reliant upon one SIP-CS.

4.3 Site Survey

Prepare the following items for the site survey.

Item		Qty	Description
Power Source	AC Adaptor	One of either	KX-A239
	User-supplied items		Battery 9–12 V Battery cable: PSJS02P57
	PoE Hub		IEEE802.3af certified
	PoE Adaptor		IEEE802.3af certified
SIP-CS		2	KX-UDS124
S-PS		1	KX-UDT111, KX-UDT121, KX-UDT131
Site map		1	Map of site or floor.
Pencil		1	To write the MAC addresses and radio signal values on the site map. ^{*1}

^{*1} Please refer to "4.5 Example of How to Make a Site Map", and write down the MAC address of each CS and radio signal values on the map.

LED Indications for Site Survey Mode

SIP-CS State	Description
Site Survey Mode	<ul style="list-style-type: none"> Red and green alternate flashing: Site Survey Master mode Slow green flashing: The site survey signal being received is good Slow amber flashing: The site survey signal being received is not good Slow red flashing: The site survey signal has been lost Moderate red flashing: No site survey signal (before receiving IP address) <p>Note</p> <p>LED flashing patterns are as follows:</p> <ul style="list-style-type: none"> Slow Flashing: 60 times per minute Moderate Flashing: 120 times per minute

Confirming SIP-CS Coverage Area for Air Synchronisation between SIP-CSs

Confirm the radio signal strength of the SIP-CS at each planned location. The SIP-CS's LED indicates the strength of the wireless connection.

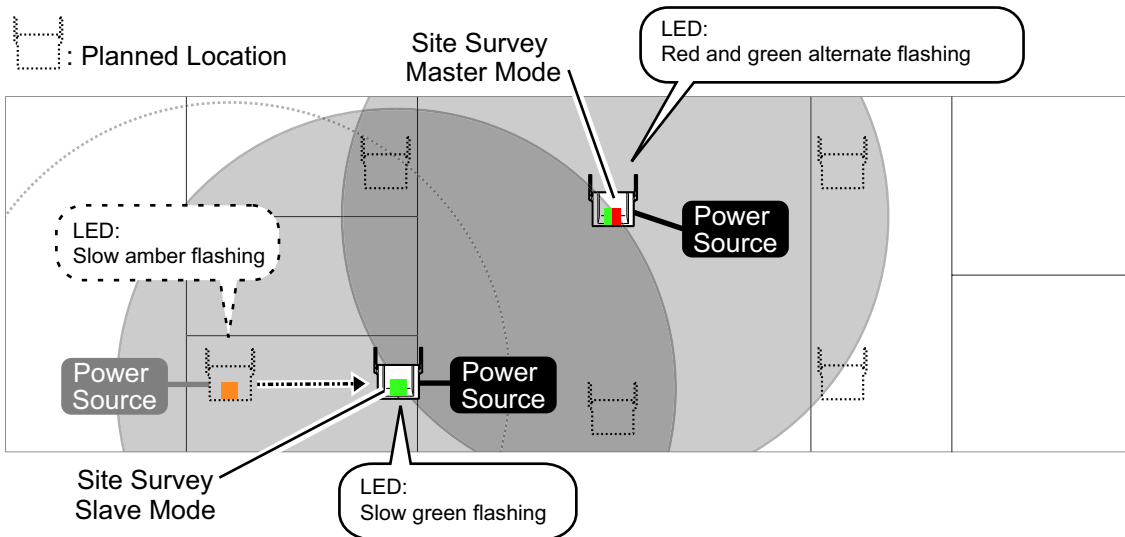

Confirming SIP-CS Coverage Area for Establishing Conversations

After confirming the SIP-CS coverage area for air synchronization, confirm the speech quality. The speech quality will be shown on the S-PS's LCD.

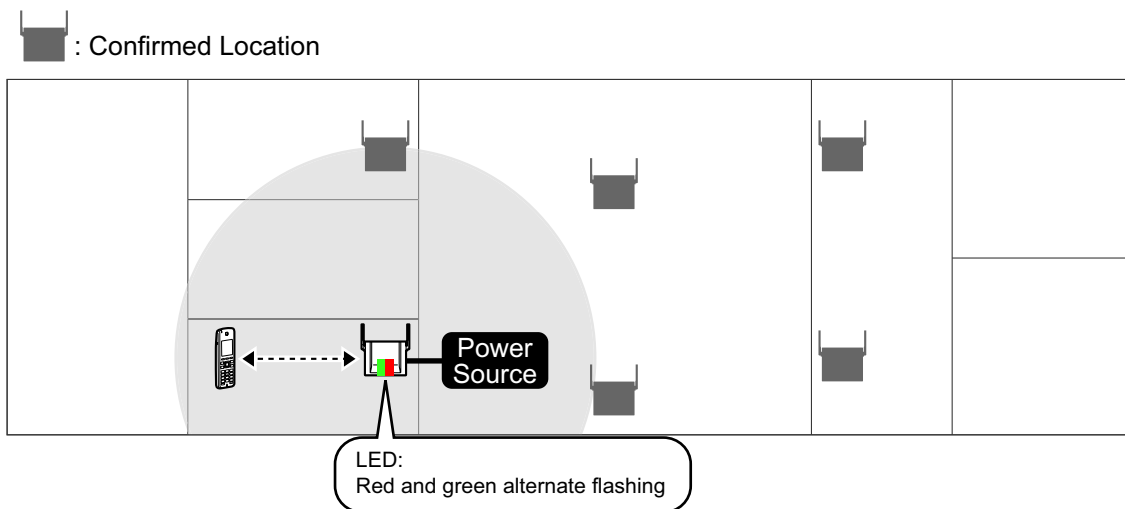

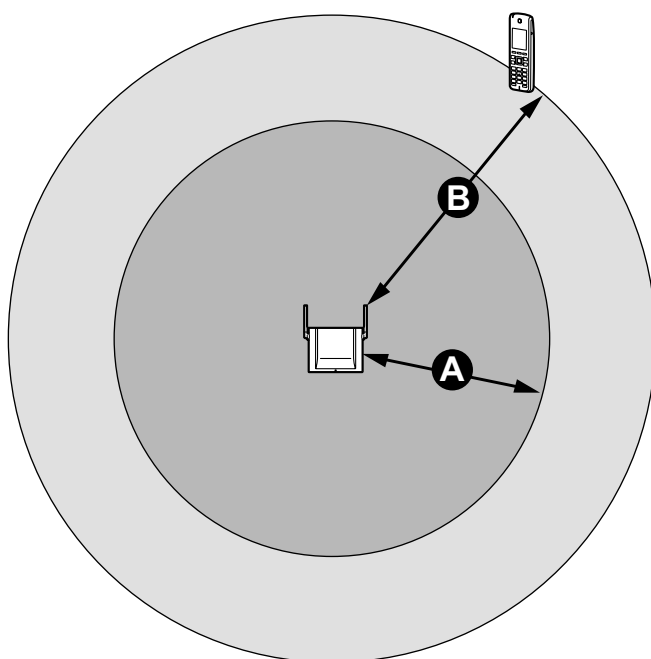

Area	Description
A	Air synchronisation coverage area (Radius: About 1 m to 40 m)
B	S-PS coverage area (Radius: About 1 m to 50 m)

Site Survey for Air Synchronisation

After completing site planning, you can use 2 SIP-CSs to conduct the site survey to check radio signal strength. Then, if necessary, modify the location of the SIP-CSs accordingly. You can check the radio signal strength by the colour of the SIP-CS's LED.

Confirming the Coverage Area for Air Synchronisation between SIP-CSs

1. Turn on SIP-CS(1) while holding the RESET switch.
2. After the LED flashes red, amber and green alternately, release the RESET switch, and then press the RESET switch again for about 1 second.
When SIP-CS(1) enters Site Survey Master mode, the LED of SIP-CS(1) flashes red and green alternately.
3. Turn on SIP-CS(2) normally. SIP-CS(2) will enter Site Survey Slave mode automatically when it receives a signal from SIP-CS(1).

4 Deployment Procedure

- Place SIP-CS(1) where the Air Sync Master CS is planned to be located.

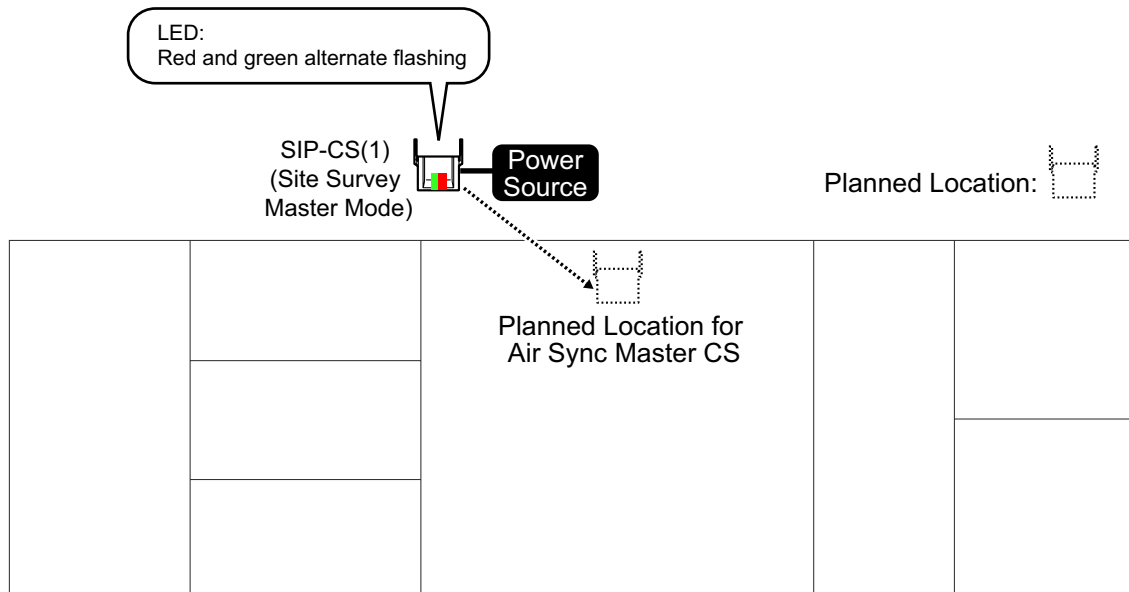

- Place SIP-CS(2) in the location planned for the SIP-CS closest to the Air Sync Master CS (currently SIP-CS[1]).

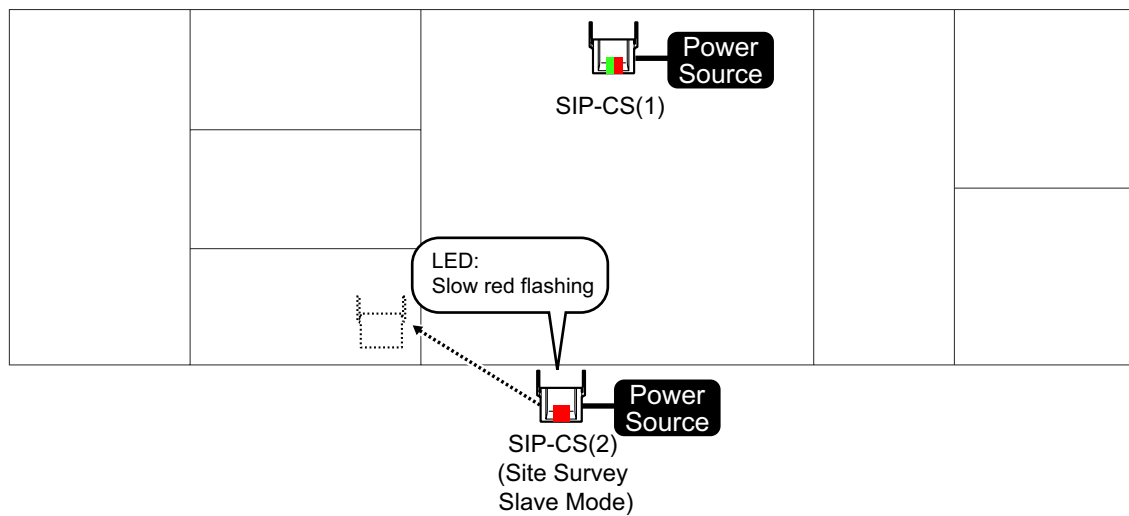

- Confirm whether the LED of SIP-CS(2) is green.
If it is not green, move SIP-CS(2) around to find a location where its LED turns green.

Note

- For air synchronisation radio signal strength details, refer to "LED Indications for Site Survey Mode" table found in "4.3 Site Survey".



- Place SIP-CS(1) where SIP-CS(2) was, and then place SIP-CS(2) in the location planned for the SIP-CS closest to current location of SIP-CS(1).

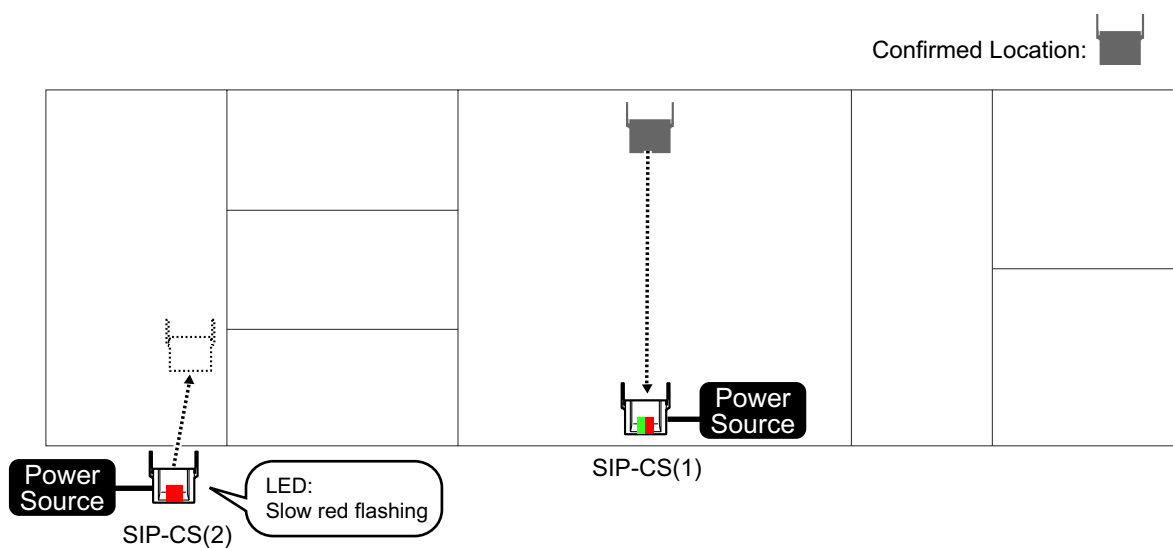

4 Deployment Procedure

8. Confirm whether the LED of SIP-CS(2) is green. If it is not green, move SIP-CS(2) around to find a location where its LED turns green.

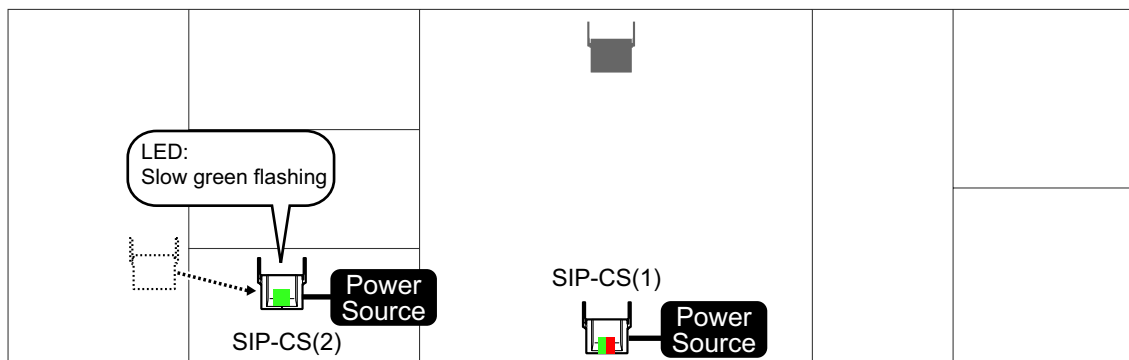
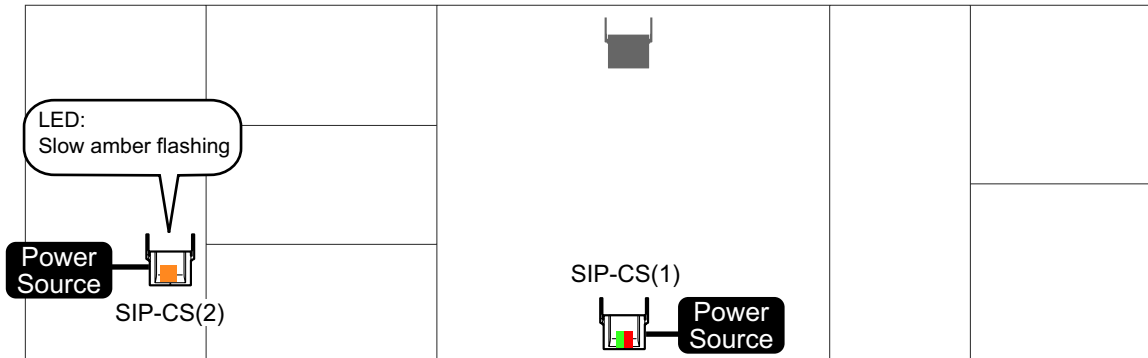

9. Repeat steps 7 to 8 for all other locations.

Site Survey for S-PS Service Area

Each S-PS has a CS Area Check mode that monitors the state of the radio link to the SIP-CS to check the S-PS service area for establishing conversations. In CS Area Check mode, the following are displayed on the S-PS with a refresh interval of 2 seconds: the SIP-CS ID of the SIP-CS to which the S-PS is connected, the radio strength level, and the Error Rate. For each confirmed SIP-CS location, set the S-PS to CS Area Check mode, and then place a SIP-CS at that location to measure the coverage area. Then, record the results on the map of the installation site. This site survey requires 1 S-PS and 1 SIP-CS.

Notice

Conduct the site survey starting with the confirmed location for Air Sync Master CS, and then go to closest location next.

Before Site Survey for S-PS Service Area

Checking the SIP-CS ID Number

Check the SIP-CS ID number label attached to the SIP-CS.

The SIP-CS ID number is attached to the rear side of the SIP-CS.

Starting the S-PS in Maintenance Mode

The S-PS must be in Maintenance mode to conduct a site survey.

To enter Maintenance mode, follow the procedure below:

Note

Before using an S-PS, the battery must be inserted and then charged for the specified amount of time. For details, refer to the documentation for the S-PS.

1. The S-PS should be in a powered off state. If the S-PS is turned on, turn it off by pressing and holding the POWER/CANCEL key.
2. Turn on the S-PS by pressing and holding the POWER/CANCEL key.

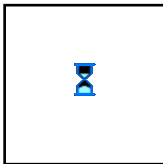

3. After turning on the S-PS, a blank screen will be displayed. At this time, press and hold the TALK/SP-PHONE key for about 8 seconds.

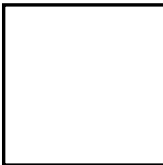

4. Press the left soft key, press **[8]**, and then press **[1]**. The Maintenance mode screen will be displayed.



5. Press **OK**.

The Maintenance mode main menu will be displayed.



Site Survey for S-PS Service Area

1. Place a SIP-CS in the location confirmed for the Air Sync Master CS in the previous site survey.
2. Supply power to the SIP-CS.
3. Perform the next step according to the registration state of the S-PS, as follows:
 - If the S-PS is unregistered, press **MON.**
 - If the S-PS is registered, start the S-PS in Maintenance mode. (For more information, see "Starting the S-PS in Maintenance Mode" above.)
Select "CS Area Check" on the S-PS, and then press **OK**.
4. Press **OK**.
The S-PS will be in CS Area Check mode and you will hear a tone.
5. Walk around the SIP-CS to confirm the SIP-CS's service area.
If the radio strength level and Error Rate are at acceptable levels, you will continue hearing a tone from the S-PS and 2 lines on the LCD of the S-PS light green.

Note

If there is an area where you cannot hear a tone and the 2 lines of the LCD do not light green, relocate the SIP-CS.

6. After confirming the service area, press POWER/CANCEL key on the S-PS to stop the tone.
7. Relocate the SIP-CS to another location.
8. Walk around the SIP-CS to confirm the SIP-CS's service area.
9. Repeat steps 7 to 8 for all the locations so that the SIP-CSs will provide service for whole area.

Radio Signal Strength Level

RSSI	Quality
13 to 17	Very Good
8 to 12	Good
4 to 7	May receive noise
Under 3	May receive noise easily or become disconnected.

Error Rate Level

Error Rate Level	Quality
0 %	Better
2 %	Good
3 %	May receive noise
10 %	May fail to make/receive calls

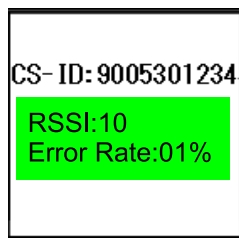

In the coverage area, the RSSI level should be more than 8 and the error rate should be less than 2 %.

Example:

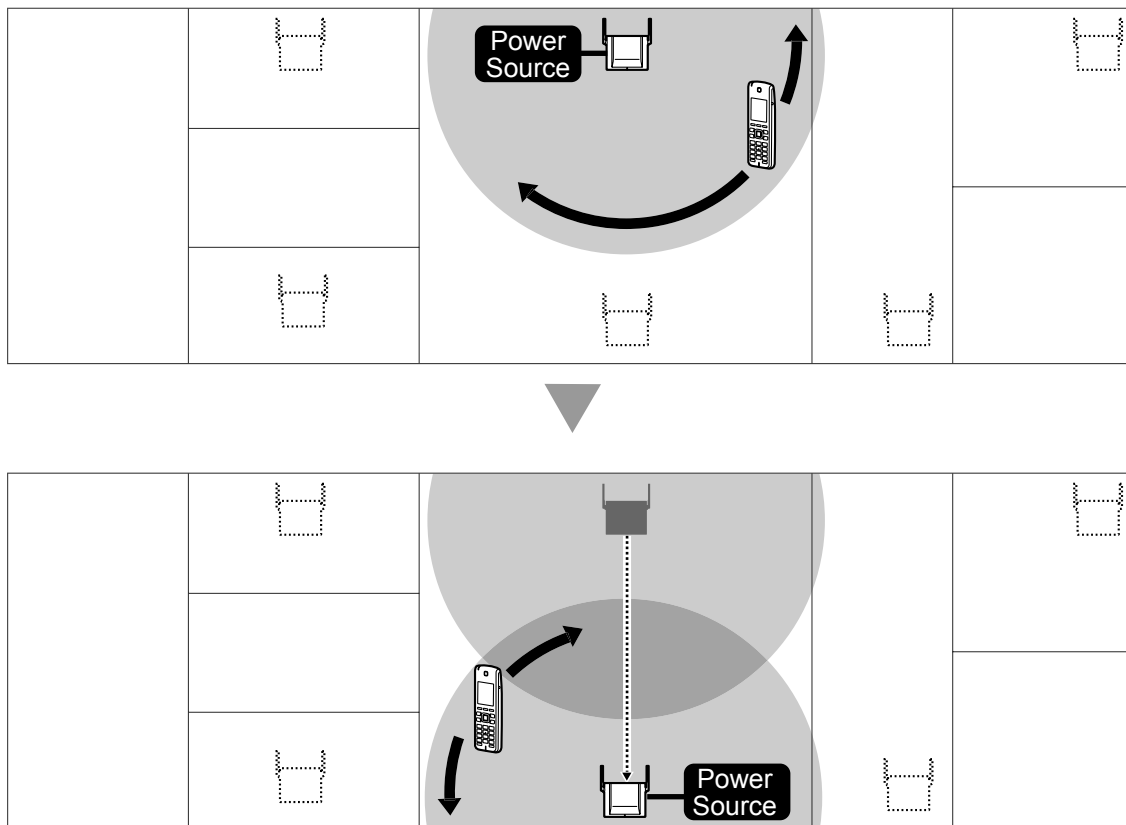

Exiting Site Survey Master Mode

While the SIP-CS is in Site Survey Master Mode, press the RESET switch to exit.

4.4 Example of How to Conduct the Site Survey

1. Set the S-PS to CS Area Check mode and walk around the site survey Master CS to confirm the CS coverage area. The recommended area is where the RSSI is more than 8 and the Error Rate is less than 02%. Then, locate the Slave CS within that area.

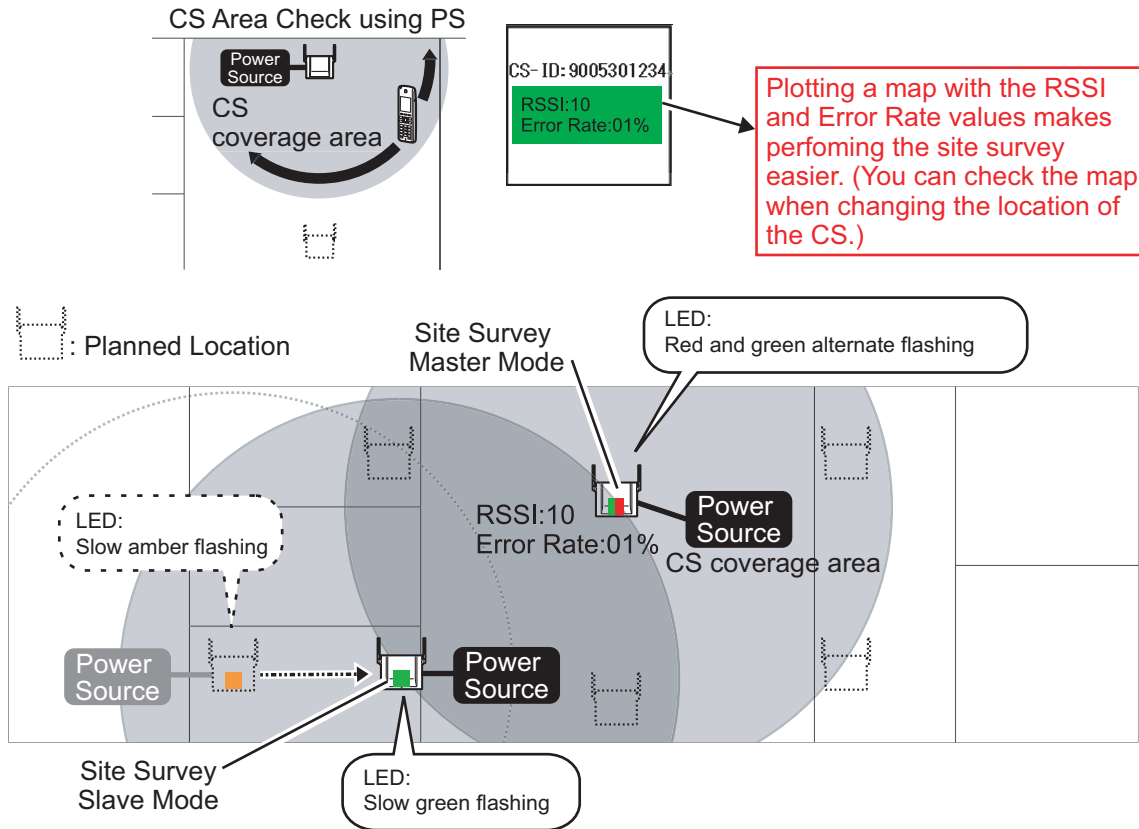

2. Confirm whether the LED of the Slave CS is now flashing green slowly. If not, move the Slave CS to a location where the LED is flashing green slowly.

After confirming the CS area using an S-PS, you need to confirm the radio signal between the Master CS and Slave CS.

3. Place the Master CS where the Slave CS was, and repeat steps 1 and 2 for all other locations.

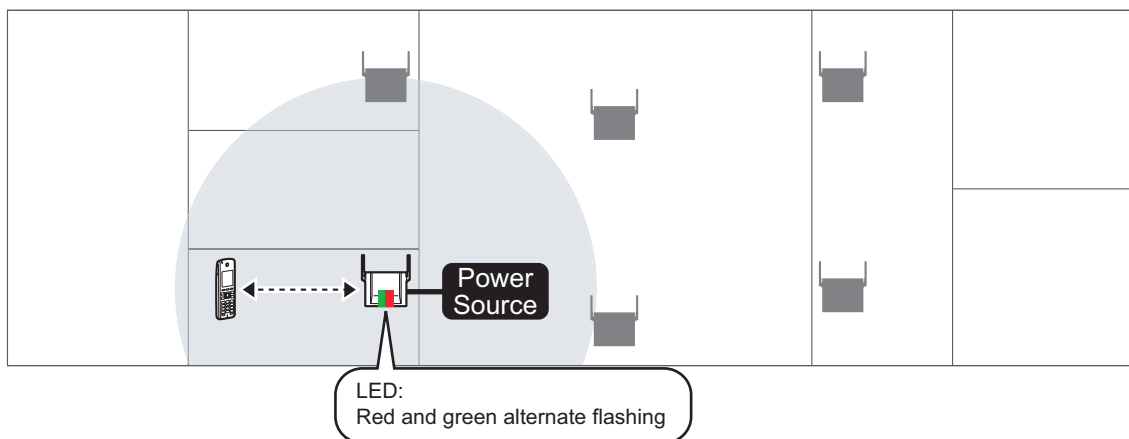

4.5 Example of How to Make a Site Map

1. Write down the MAC address of each CS on the map. (The MAC address is written on the rear side of each CS.)
In case of network trouble, you can confirm which CS is not connected using the map.

Example of Site MAP (1) (CS MAC addresses)

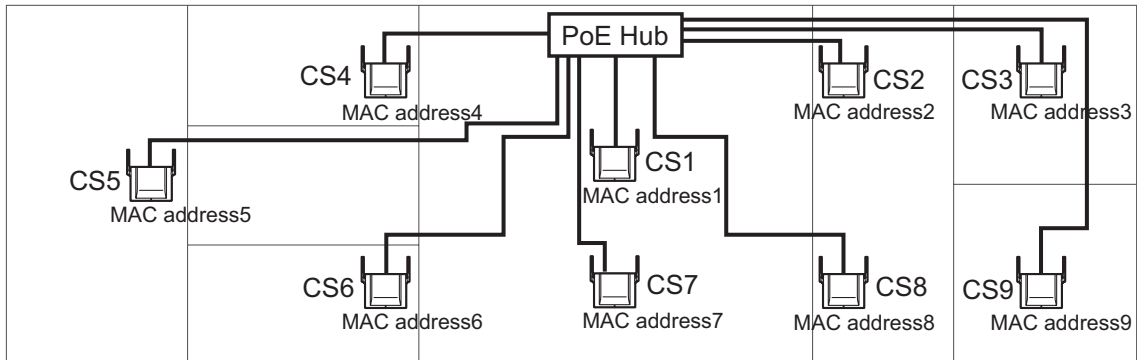

2. Write down the radio signal values (RSSI and Error Rate) around the next CS location and near important places such as meeting rooms, on the map.
You can use this as a guide when changing the location of the CS.

Example of Site MAP (2) (Radio signal conditions)

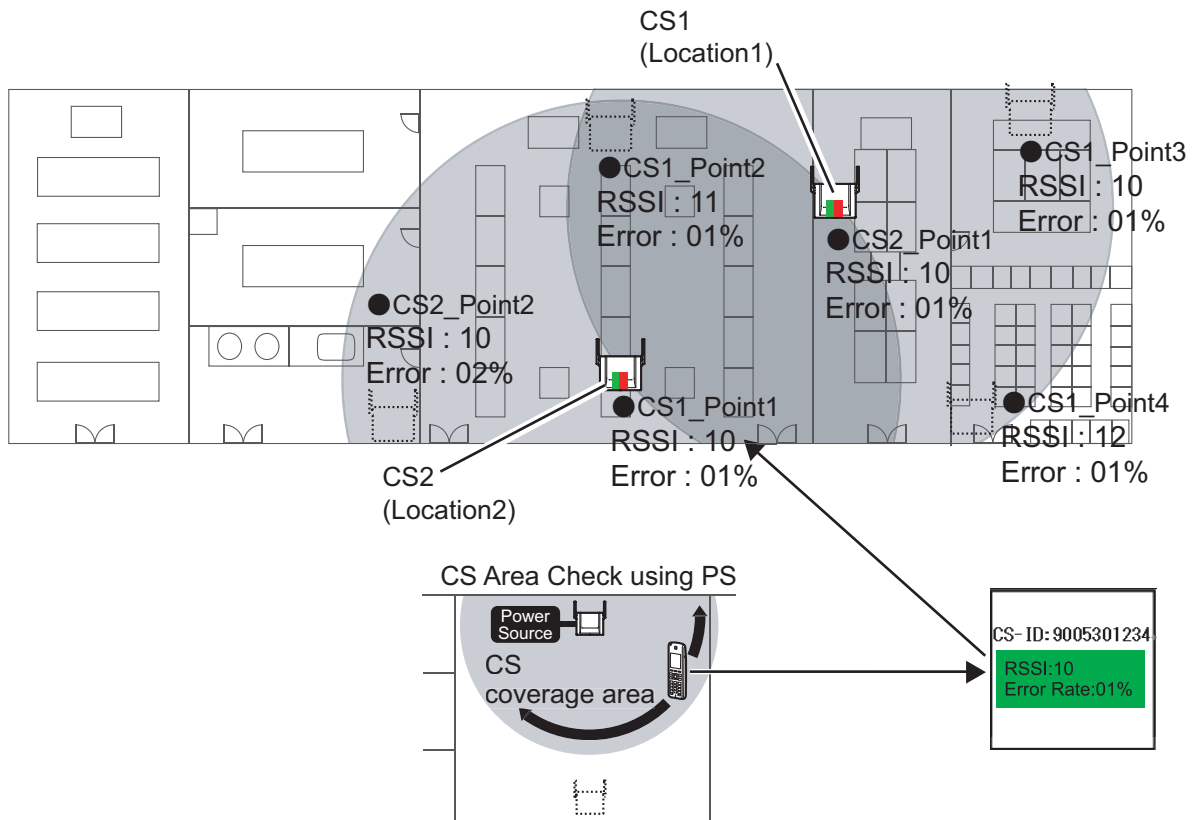

4.6 Basic Network Configuration

Configuring Network Settings for Air Sync Master CS

Setting Up with a Fixed IP Address

1. Turn on the SIP-CS while holding the RESET switch.
2. After the LED flashes red, amber and green alternately, release the RESET switch.

Note

The IP address and subnet mask are as follows:

- IP address: 192.168.0.241
- Subnet mask: 255.255.255.0

Logging in to the Web User Interface

1. Connect a PC to the SIP-CS intended to serve as the Super Master CS.
2. Start a Web browser on the PC.
3. Enter the default IP address of the SIP-CS in the browser's address bar.
4. Log in to the SIP-CS as the administrator.

Note

The default ID and password for the administrator are as follows:

- ID: admin
- Password: adminpass

Assigning IP Address Information

Panasonic

SIP CS KX-UDS124

Status | **Network** | System | VoIP | Telephone | Maintenance

Web Logout
Web Port Close

Basic Network Settings

Network

- Basic Network Settings
- HTTP Client Settings
- HTTP Authentication
- Global Address Detection

Connection Mode

Connection Mode DHCP Static

DHCP Settings

Host Name

Receive DNS server address automatically

Use the following settings

Domain Name Server

DNS1

DNS2

Static Settings

Static IP Address

Subnet Mask

Default Gateway

DNS1

DNS2

Link Speed/Duplex Mode

LAN Port

The CS reboots automatically if you change the settings on this item.

LLDP Settings

Enable LLDP Yes No

LLDP-MED Interval timer seconds [1-3600]

IP Phone

VLAN ID

Priority

The CS reboots automatically if you change the settings on this item.

VLAN Settings

Enable VLAN Yes No

IP Phone

VLAN ID [1-4094]

Priority

The CS reboots automatically if you change the settings on this item.

Save Cancel

The Super Master CS must have a static IP address. Follow the procedure below to configure static IP address information. (The following procedure can be omitted for Air Sync Groups 2–8.)

1. In the **Network** tab, select **Basic Network Settings**.
2. In **Connection Mode**, select **Static**.
3. Enter the IP address of the Super Master CS in **Static IP Address**.
4. Enter the subnet mask in **Subnet Mask**.
5. Enter the IP address of the default gateway in **Default Gateway**.
6. Enter the IP address of the primary DNS server in **DNS1**.
7. Enter the IP address of a secondary DNS server in **DNS2**.
8. Click **Save**.

Note

- After saving changes on the **Basic Network Settings** screen, the changed settings will be applied when **Complete** appears after clicking **Save**.
- The IP addresses of the SIP-CSs may change if changes are made on the **Basic Network Settings** screen. In this case, log in to the Web user interface again using the newly assigned IP address for the SIP-CS. In addition, changing the IP address of the PC that is connected to the SIP-CS may be required.

Configuring Air Synchronisation Settings

Panasonic
SIP CS KX-UDS124 | Status | Network | **System** | Maintenance

Web Logout
Web Port Close

System

Air Settings

Air Sync Group
Air Sync Group: 1

CS Class
It is necessary to execute Tree Survey again if you change this mode.
CS Class: Master Second Master Slave

Super Master CS IP Address
IP Address:

Save Cancel

The CS reboots automatically if you change the settings on this screen.

Follow the procedure below to change the SIP-CS status to **Master**.

1. In the **System** tab, select **Air Settings**.
2. Select an Air Sync Group. (Group 1 must be selected for the Super Master CS.)
3. In **CS Class**, select **Master**.
4. Enter the IP address of the Super Master CS in **IP Address**. (This step can be omitted for the Super Master CS.)
5. Click **Save**.
The SIP-CS will restart automatically.
The SIP-CS is now set as an Air Sync Master CS. You may exit Site Survey Mode.

Changing the Administrator Password

Panasonic
SIP CS KX-UDS124 | Status | Network | **System** | VoIP | Telephone | Maintenance

Web Logout
Web Port Close

System

Change Administrator Password

Change Administrator Password

Current Password:

New Password: 8-16 characters

Confirm New Password:

All Save Cancel

Note

This setting is required only for the Super Master CS.

1. In the **System** tab, select **Administrator Password**.
2. Enter the default password in **Current Password**.
3. Enter a new password in **New Password**.
4. Enter the new password again in **Confirm New Password**.
5. Click **All Save**.

6. Log out from the Web User Interface, and then log in again.
The new password will be saved and the SIP-CS will restart.

Note

The new password will be applied to all registered SIP-CSs automatically.

Password Security**CAUTION**

- For security reasons, change the administrator password after logging in to the Web user interface for the first time.
- To avoid unauthorised access and possible abuse of your phone system, we strongly recommend:
 - Keeping the password secret.
 - Changing your password regularly.
 - Selecting a complex, random password that cannot be easily guessed.

Connecting SIP-CSs to the LAN

Follow the procedure below to connect SIP-CSs to the LAN.

1. Disconnect the Super Master CS from the PC.
2. Place the Super Master CS in its planned location, and then connect it to the LAN.
3. Turn the Super Master CS on.
4. Place the other SIP-CSs in their planned locations, and then connect them to the LAN.
5. Turn the SIP-CSs on.
All the SIP-CSs (except Super Master CS) will automatically acquire their IP address from the DHCP server.

Note

- For details about connecting a SIP-CS to LAN, see "Connecting a SIP-CS to a LAN" in "3.2 Connecting SIP Cell Stations".
- All the SIP-CSs except the Super Master CS will receive a signal from the Super Master CS and automatically enter Site Survey mode.

4.7 CS Registration

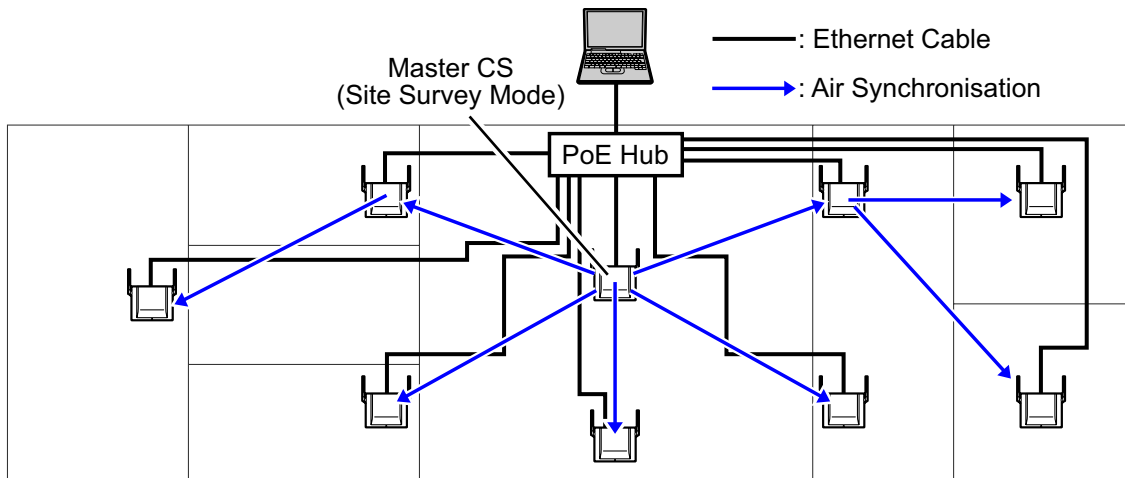

Notice

- Connect each SIP-CS in the Air Sync Group to the network and turn them on.
- During CS Registration, make sure that all unregistered SIP-CSs that are not in the Air Sync Group you are registering are turned off.

Confirming the MAC addresses of all the SIP-CS

To register SIP-CSs to the Air Sync Master CS, the MAC address of each SIP-CS is required. The MAC address is written on the rear side of each SIP-CS. Confirm the MAC address of each SIP-CS before registering it.

Before registering

For the Super Master CS

- Provide a static IP address which can be used on your network.
For details, refer to "Assigning IP Address Information" in "4.6 Basic Network Configuration".

For Air Sync Master CSs other than Super Master CS

- Set the IP address of the Super Master CS.
- Set the IP address type (DHCP or Static)

For Slave CSs

- Set the IP address type (DHCP or Static)

For SIP-CSs that have been used before

- Initialise the SIP-CS to restore settings to their factory defaults.
 1. Turn on the SIP-CS.
 2. Press and hold the RESET switch until the LED turns off (about 10 seconds).

Note

After initialising the SIP-CS, configure network settings if necessary. For information about configuring network settings, see "4.6 Basic Network Configuration".

Registering SIP-CSs to the Air Sync Master CS (Air Sync Group 1)

Panasonic
SIP CS KX-UDS124

Status Network **System** VoIP Telephone Maintenance

Web Logout
Web Port Close

CS Management

System

Web Language
Administrator Password
Change User Password
Web Server Settings
Time Setting
Time Adjust Settings
CS Name
Air Settings
CS Management
Tree Survey
CS Monitor
PS Registration
-PS Settings

CS Registration

Air Sync Group: 1
Number of CS: 30
Start CS Registration
Stop CS Registration
Only CS that has a check in the check box can be deleted.
Delete CS Registration

CS Registered List

All

No.	Index	CS Name CS ID	MAC Address IP Address	CS Class	Remote Login
1	1	01973103D0	00.80.F0.E9.74.40 192.168.0.103	Master	
2	2	0018E58900	00.80.F0.AC.67.44 192.168.0.142	Slave	Login
3					
4					
5					
6					

1. In the **System** tab, select **CS Management**.
2. Select the number of SIP-CSs to register newly from the **Number of CS** pull-down menu.
3. Click **Start CS Registration**.
4. Click **OK**.
All the SIP-CSs on the LAN will be registered, and then displayed in **CS Registered List**.

Note

- After clicking **Start CS Registration**, when the number of registered SIP-CSs reaches the number specified in **Number of CS**, "Complete" is displayed and registration stops automatically.
- Click **Stop CS Registration** to quit registration.
- If you want to register all SIP-CSs in step 2, select the maximum number of SIP-CSs. In this case, after the detected SIP-CSs have been registered, wait 5 minutes for the timeout display or click **Stop CS Registration**.
- After registration, check the **CS Registered List** to confirm that the SIP-CSs have been registered.

Notice

You cannot register the following SIP-CSs:

- SIP-CSs that are not turned on
- SIP-CSs that are not connected to the network
- SIP-CSs for which no IP address has been set
- SIP-CSs that cannot receive radio signals from the Air Sync Master CS

Registering SIP-CSs to the Air Sync Master CS (Air Sync Groups 2–8)

1. In the **System** tab, select **CS Management**.
2. Select an **Air Sync Group**.
3. Select the number of SIP-CSs to register from the **Number of CS** pull-down menu.
4. Click **Start CS Registration**.
5. Click **OK**.

Note

- At first, the **CS Registered List** for Air Sync Groups 2–8 is blank.

4 Deployment Procedure

- After clicking **Start CS Registration**, when the number of registered SIP-CSs reaches the number specified in **Number of CS**, "Complete" is displayed and registration stops automatically.
- Click **Stop CS Registration** to quit registration.
- If you want to register all SIP-CSs in step 3, select the maximum number of SIP-CSs. In this case, after the detected SIP-CSs have been registered, wait 5 minutes for the timeout display or click **Stop CS Registration**.
- After registration, check the **CS Registered List** to confirm that the SIP-CSs have been registered.

Notice

- After registering the SIP-CS to the Air Sync Master CS, when the SIP-CS cannot connect to the Air Sync Master CS, the LED of the SIP-CS flashes red slowly.

4.8 Tree Survey

The Tree Survey creates the most suitable synchronisation tree automatically for SIP-CSs. You also can configure Air Sync Groups in this procedure.

The Tree Survey creates a Master/Slave tree structure with the Air Sync Master CS at the top and with stable air synchronisation. The procedure can be performed automatically by using either the Web user interface or the CS maintenance tool. The Tree Survey not only specifies the level for each SIP-CS, but also a primary and secondary synchronising CS from which the SIP-CS will receive its clock signal. The secondary synchronising CS is used as a backup so that if the primary synchronising CS fails the whole system will not be affected.

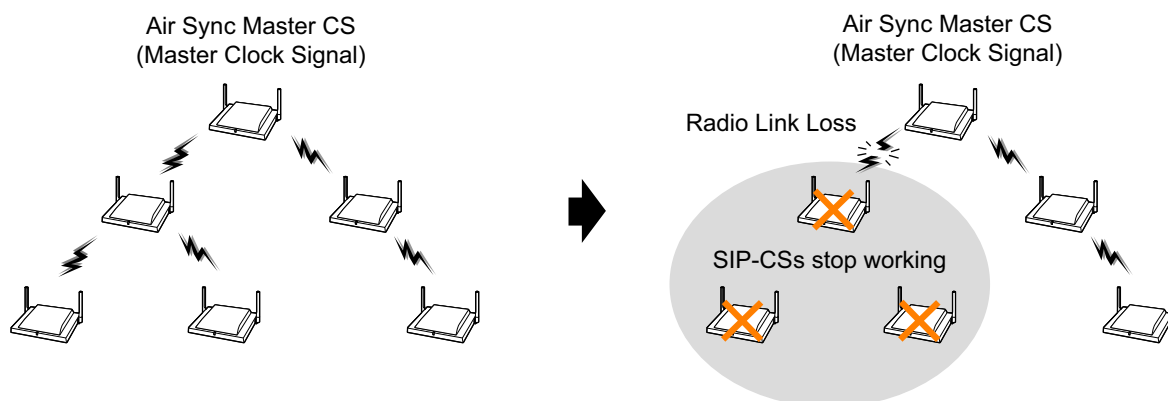

Conducting the Tree Survey

Note

The result of the Tree Survey will be shown in a new pop-up window. Make sure the pop-up blocker is disabled on your browser.

Panasonic

SIP CS KX-UDS124

Status Network **System** VoIP Telephone Maintenance

Web Logout

Web Port Close

Tree Survey

Air Sync Group: 1

This "Tree Survey" is executed to all the CS in Survey List.

Tree Survey:

This "Result Application" is executed to all the CS in Survey List.

Result Application:

The CS reboots automatically if you press the button of "Apply" or "Cancel".

Survey List

Index	CS Name MAC Address	CS Class	Status	Primary CS Index	Secondary CS Index	Level
1	0080F0E975F9	Master	INS	-	-	-
2	0080F0D755E7	Slave	-	1	-	1
4	0080F0E97605	2nd Master	-	1	-	1

Follow the procedure below to put the SIP-CSs in Tree Survey mode.

1. In the **System** tab, select **Tree Survey**.
2. Select an **Air Sync Group**.
3. Confirm that all SIP-CSs status are "INS" or "-".

4. Click **Start Tree Survey**.
5. Click **OK**.
6. After the Tree Survey has completed, results will be displayed.
7. Click **OK**.

Note

Click **Tree Image** to see a connection diagram of the SIP-CSs

Notice

If the Tree Survey will be conducted for 10 or more SIP-CSs, use the CS Maintenance Tool instead. For details, see "4. Tree Survey" in "4.1 Overview".

Note

If necessary, you can relocate SIP-CSs and conduct the Tree Survey again.

Applying the Tree Survey Results

Follow the procedure below to apply the parent-child settings from Tree Survey results to the registered SIP-CSs.

1. Click **Apply**.
2. Click **OK**.

Note

- After clicking **OK**, all SIP-CSs will restart.
- If you do not want to apply the Tree Survey results, click **Cancel** to exit Tree Survey mode. After clicking **Cancel**, all SIP-CSs will restart.

Manually adding a SIP-CS at the End of the Connection Tree

You can add SIP-CSs at the end of the connection diagram manually. This is useful when you want to expand the SIP-CS coverage area.

1. Register a SIP-CS to the Air Sync Group for which you want to extend the SIP-CS coverage area.
2. Log in to the Super Master CS.
3. In the **System** tab, select **Tree Survey**.
4. Select an **Air Sync Group**.
5. The SIP-CS registered in step 1 is shown at the bottom of the **Survey List**. Enter the SIP-CS index number of the SIP-CS that you want to specify as a Primary CS in **Primary CS Index** for the registered SIP-CS.
6. Click **Apply**.
7. Click **OK**.

Note

- You cannot add a SIP-CS at the end of level 8.
- When you want to add SIP-CSs to the middle of the connection diagram, please conduct the Tree Survey again.
- When you want to change the Secondary CS, change **CS Class**, click **Apply** and then click **OK**.

4.9 Configuration and PS Registration (for a system using a KX-NS1000)

4.9.1 Programming using Web Maintenance Console

The following items must be programmed using the KX-NS1000's Web Maintenance Console.

- V-UTEXT32 card (Virtual UT Extension Card)
- Extension settings for S-PSs
- Extension number for the Super master CS

Logging into Web Maintenance Console

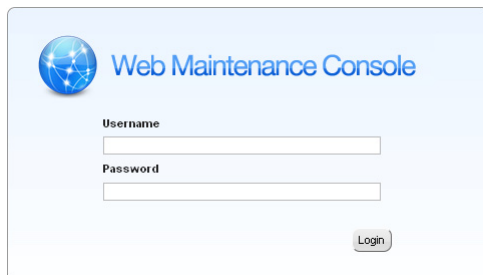

1. Connect a PC to the KX-NS1000.
2. Access Web Maintenance Console.
When the PC is connected to the KX-NS1000 on the same LAN, launch your Web browser and input the IP address of the PBX followed by the Web Maintenance Console port number into the address bar. The default IP address for the LAN port of the PBX is 192.168.0.101, and the default Web Maintenance Console port number is 80. Accordingly, the address to enter to connect to the PBX for the first time will be as follows (enter the address exactly as shown):
`http://192.168.0.101`

Note

The default subnet mask for the LAN port is 255.255.255.0.

3. The Web Maintenance Console login screen is displayed. Log in with the Installer account.

Adding a V-UTEXT32 Card to the KX-NS1000

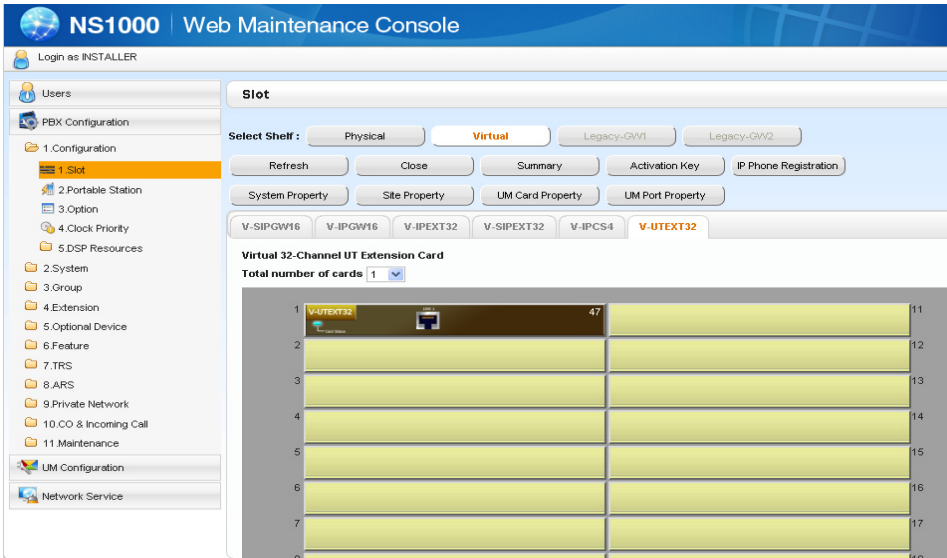

1. Click **Setup** → **PBX Configuration** → **Configuration** → **Slot** → **Virtual**.
2. Click on the **V-UTEXT32** tab.
3. Select the number of cards to install of that type from the **Total number of cards** drop-down list. The selected number of cards will fill free virtual slots.
4. Click **OK**.

Programming Extension Settings for S-PSs

The KX-NS1000 assigns extension numbers to S-PSs automatically. However, you can also specify desired extension numbers manually.

To assign extension numbers to S-PSs manually, follow the procedure below.

Assigning an extension number to an S-PS

ID	Site	Shelf	Slot	Port	Extension Number	Extension Name	Test
1	1	Virtual	47	1	5378		UT
2	1	Virtual	47	2	5379		UT
3	1	Virtual	47	3	5380		UT
4	1	Virtual	47	4	5381		UT
5	1	Virtual	47	5	5382		UT
6	1	Virtual	47	6	5383		UT
7	1	Virtual	47	7	5384		UT
8	1	Virtual	47	8	5385		UT
9	1	Virtual	47	9	5386		UT
10	1	Virtual	47	10	5387		UT
11	1	Virtual	47	11	5388		UT
12	1	Virtual	47	12	5389		UT
13	1	Virtual	47	13	5390		UT

1. Click **Setup** → **PBX Configuration** → **Configuration** → **Slot** → **Virtual**.
2. Click on the **V-UTEXT32** tab.
3. Move the mouse pointer over the V-UTEXT32 card (Virtual UT Extension Card). A menu will be shown under the mouse pointer.
4. Click **Port Property**.
5. Enter the desired extension number in the **Extension Name** column.
6. Click **OK**.

Programming Extension Settings

No.	Extension Number	Extension Name (20 characters)	Site	Shelf	Slot	Port	Po
1	101		1	1	1	1	SLT
2	102		1	1	1	2	SLT
3	103		4	2	11	1	S-Hybrid
4	104		4	2	11	2	S-Hybrid
5	105		4	2	11	3	S-Hybrid
6	106		4	2	11	4	S-Hybrid
7	107		4	2	11	5	S-Hybrid
8	108		4	2	11	6	S-Hybrid
9	109		4	2	11	7	S-Hybrid
10	110		4	2	11	8	S-Hybrid
11	111		4	2	11	XDP1	S-Hybrid
12	112		4	2	11	XDP2	S-Hybrid
13	113		4	2	11	XDP3	S-Hybrid
14	114		4	2	11	XDP4	S-Hybrid

1. Click **Setup** → **PBX Configuration** → **Extension** → **Wired Extension** → **Extension Settings**.
2. Configure the extension name and required settings for the extension.
3. Click **OK**.

Programming Flexible buttons

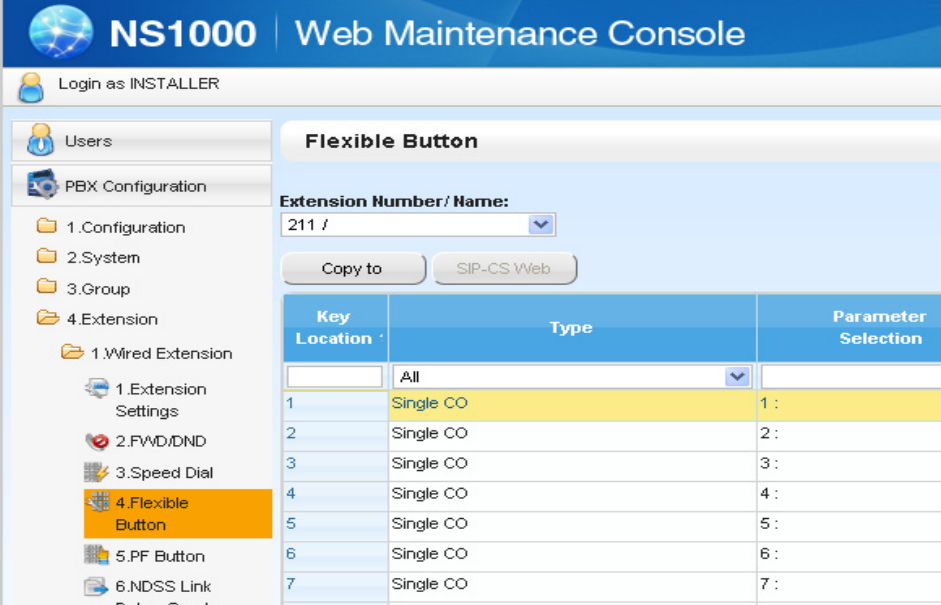

The screenshot shows the NS1000 Web Maintenance Console interface. The left sidebar contains a navigation menu with the following items: Users, PBX Configuration, 1. Configuration, 2. System, 3. Group, 4. Extension, 1. Wired Extension, 1. Extension Settings, 2. FWD/DND, 3. Speed Dial, 4. Flexible Button (highlighted), 5. PF Button, and 6. NDSS Link. The main content area is titled 'Flexible Button' and features an 'Extension Number/ Name:' field with a dropdown menu showing '211 /'. Below this are 'Copy to' and 'SIP-CS Web' buttons. A table with three columns is displayed: 'Key Location', 'Type', and 'Parameter Selection'. The table contains seven rows, with the first row highlighted in yellow.

Key Location	Type	Parameter Selection
	All	
1	Single CO	1 :
2	Single CO	2 :
3	Single CO	3 :
4	Single CO	4 :
5	Single CO	5 :
6	Single CO	6 :
7	Single CO	7 :

1. Click **Setup** → **PBX Configuration** → **Extension** → **Wired Extension** → **Flexible Button**.
2. Programme the flexible buttons.

Note

You can programme the following flexible buttons to S-PSs. For details about each flexible button, refer to the Feature Guide of the KX-NS1000.

- SCO
- DN
- LOGIN/LOGOUT
- DSS
- CALLPARK
- WRAPUP
- ONETOUCH

3. Click **OK**.

Programming an Extension Number for the Super Master CS

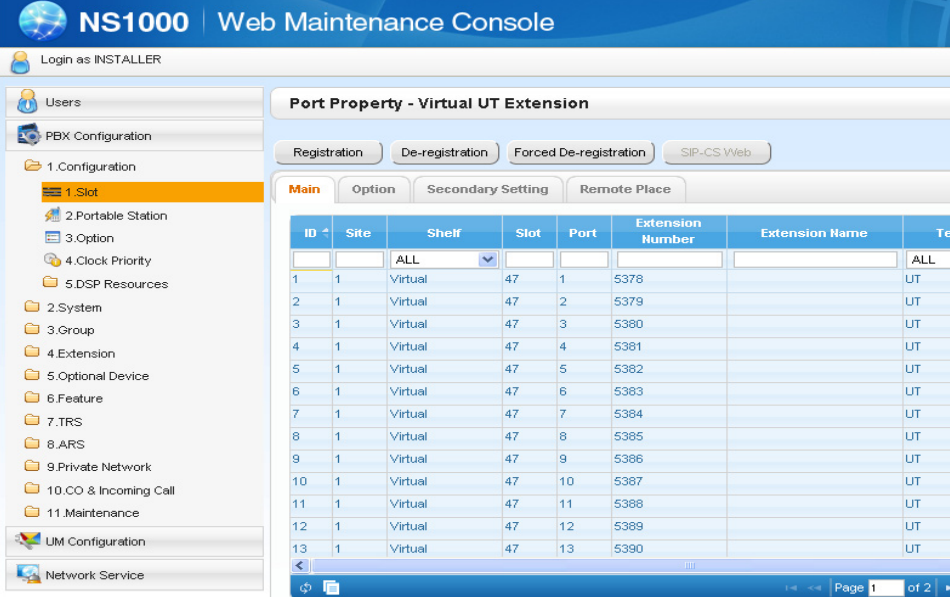

The screenshot shows the NS1000 Web Maintenance Console interface. The main content area is titled "Port Property - Virtual UT Extension" and contains a table with the following data:

ID	Site	Shelf	Slot	Port	Extension Number	Extension Name	Te
1	1	Virtual	47	1	5378		UT
2	1	Virtual	47	2	5379		UT
3	1	Virtual	47	3	5380		UT
4	1	Virtual	47	4	5381		UT
5	1	Virtual	47	5	5382		UT
6	1	Virtual	47	6	5383		UT
7	1	Virtual	47	7	5384		UT
8	1	Virtual	47	8	5385		UT
9	1	Virtual	47	9	5386		UT
10	1	Virtual	47	10	5387		UT
11	1	Virtual	47	11	5388		UT
12	1	Virtual	47	12	5389		UT
13	1	Virtual	47	13	5390		UT

1. Click **Setup** → **PBX Configuration** → **Configuration** → **Slot**.
2. Click **Virtual** → **V-UTEXT32**.
3. Move the mouse pointer over the V-UTEXT32 card (Virtual UT Extension Card).
A menu will be shown under the mouse pointer.
4. Click **Port Property**.
5. Enter the desired extension number in the corresponding **Extension Number** cell.

Note

It is recommended to use Web Maintenance Console in on-line mode to change the extension number and password for the Super Master CS. If the extension number and password of the Super Master CS are changed in off-line mode, the change may not take effect correctly. In this case, reset each SIP-CS to let the change take effect correctly. For details about resetting each SIP-CS, see the Administrator Guide.

Specifying a Terminal Type for S-PSs, SIP-CSs and the Super Master CS

ID	Site	Shelf	Slot	Port	Extension Number	Extension Name	Telephone Type	Connection
1	1	Virtual	47	1	5378		ALL	Fault
2	1	Virtual	47	2	5379		UT	Fault
3	1	Virtual	47	3	5380		UT	Fault
4	1	Virtual	47	4	5381		UT	Fault
5	1	Virtual	47	5	5382		UT	Fault
6	1	Virtual	47	6	5383		UT	Fault
7	1	Virtual	47	7	5384		UT	Fault
8	1	Virtual	47	8	5385		UT	Fault
9	1	Virtual	47	9	5386		UT	Fault
10	1	Virtual	47	10	5387		UT	Fault
11	1	Virtual	47	11	5388		UT	Fault
12	1	Virtual	47	12	5389		UT	Fault
13	1	Virtual	47	13	5390		UT	Fault

1. Click **Setup** → **PBX Configuration** → **Configuration** → **Slot**.
2. Click **Virtual** → **V-UTEXT32**.
3. Move the mouse pointer over the V-UTEXT32 card (Virtual UT Extension Card).
A menu will be shown under the mouse pointer.
4. Click **Port Property**.
5. Select **SIP-CS** for SIP-CSs and **S-PS** for S-PSs in the **Telephone Type** column.

Note

Make sure that the port for the SIP-CS or S-PS is in OUS status when changing **Telephone Type**.

6. Click **OK**.
7. Move the mouse pointer over the installed V-UTEXT32 card to display the menu of options, and click **Ins** (In service) to set the card back to in service.
A configuration file for the system is created.

Note

If you perform one of the following, the configuration file will be re-created.

- Changing the V-UTEXT32 card status from "OUS" to "INS"
- Restarting the KX-NS1000.
- Changing the following settings:
 - Extension number
 - Extension name
 - Flexible button

4.9.2 Programming using the Web User Interface

The following items must be programmed using the Web user interface.

- KX-NS1000 URL for downloading configuration file
- Registering S-PSs to the Super Master CS

For details about Web user interface operation, refer to "Web User Interface Programming" in the Administration Guide.

Specifying the URL to Access the KX-NS1000

The screenshot shows the Panasonic SIP CS KX-UDS124 Web Maintenance Console. The 'Maintenance' tab is selected in the top navigation bar. On the left, a sidebar menu lists various maintenance options, with 'Provisioning Maintenance' highlighted. The main content area is titled 'Provisioning Maintenance' and contains the following fields and controls:

- Web Logout
- Web Port Close
- Enable Provisioning: Yes No
- Standard File URL:
- Product File URL:
- Master File URL:
- System File URL:
- Cyclic Auto Resync: Yes No
- Resync Interval: minute(s) [1-40320]
- Header Value for Resync Event:
- All Save
- Cancel

1. Login to the Web user interface as the administrator.
2. Click **Maintenance** → **Provisioning Maintenance**.
3. Enter the IP address and port number of the KX-NS1000 as shown below in **System File URL**.
http://xxx.xxx.xxx.xxx:yyyy/utdownload/System.cfg

Note

- For details about the IP address and port number, consult your network administrator.
 - xxx.xxx.xxx.xxx: IP address for accessing the KX-NS1000.
 - yyyy: Port number specified in **Site Property—Main—Port Number Data Transmission Protocol (HTTP) PortNo. for SIP-MLT** (default: 7580) in Web Maintenance Console.
 - Do not enter any value in **Standard File URL**, **Product File URL**, or **Master File URL**.
4. Click **All Save**.
The Super Master CS will start downloading the programmed information from the KX-NS1000.

4.9.3 Registering S-PSs to the Super Master CS

Registering S-PSs to the Super Master CS

Follow the procedure in "Starting Registration Mode" in "4.10.2 PS Registration".

Registering S-PSs to the KX-NS1000

When the extension number and PIN that is registered to the KX-NS1000 with Web Maintenance Console match the S-PS information registered to the Super Master CS, registration to the KX-NS1000 starts automatically. (No operation is required on the S-PSs.)

4.9.4 Programming PS Ring Group

Overview of the PS Ring Group feature with SIP-CSs

SIP-CSs can provide the PS ring group feature. To use the feature, you must set the PS Ring Group setting of the SIP-CS and the ICD group setting of the KX-NS1000.

A PS Ring Group of the SIP-CS is a group of S-PS extensions that receive the same incoming calls. Each PS Ring Group has a floating extension number and name. The floating extension number is assigned to an ICD group to be used for calling multiple S-PSs simultaneously. One S-PS can belong to multiple PS Ring Groups.

Required settings for the KX-NS1000

Use Web Maintenance Console of the KX-NS1000 to program the following items.

- Extension number setting:
Extension number must be assigned for all the SIP-CSs.
[Example]

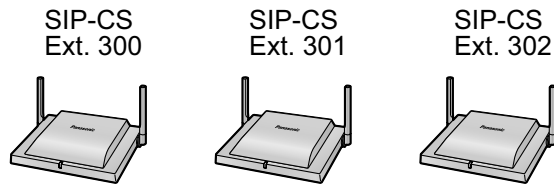

- ICD group setting:
All the extension numbers assigned to the SIP-CSs must be specified as members of an ICD group.
[Example]

<p>ICD Group 1</p> <p>Floating extension no.: 600</p> <p>Members: 300, 301, 302 (Extension numbers of the SIP-CSs)</p>	<p>ICD Group 2</p> <p>Floating extension no.: 601</p> <p>Members: 300, 301, 302 (Extension numbers of the SIP-CSs)</p>
---	---

Required settings for the SIP-CS

Use the Web user interface of the Super Master CS to program the following items.

- PS Ring Group setting:
Create a PS Ring Group which contains the floating extension number of the ICD group that includes the S-PSs to which you wish incoming calls to be broadcasted.

Note

The floating extension number assigned to the ICD groups (e.g., 600) is used for calling multiple S-PSs simultaneously.

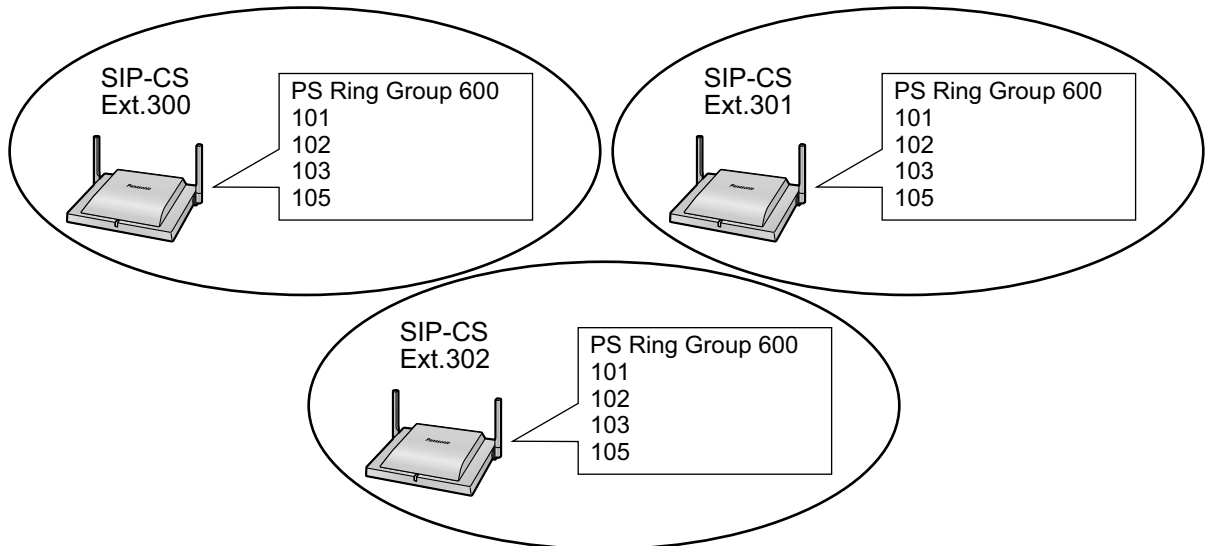

4 Deployment Procedure

The following illustration is an example of an incoming call received by S-PSs with the ICD group setting and PS Ring Group setting enabled.

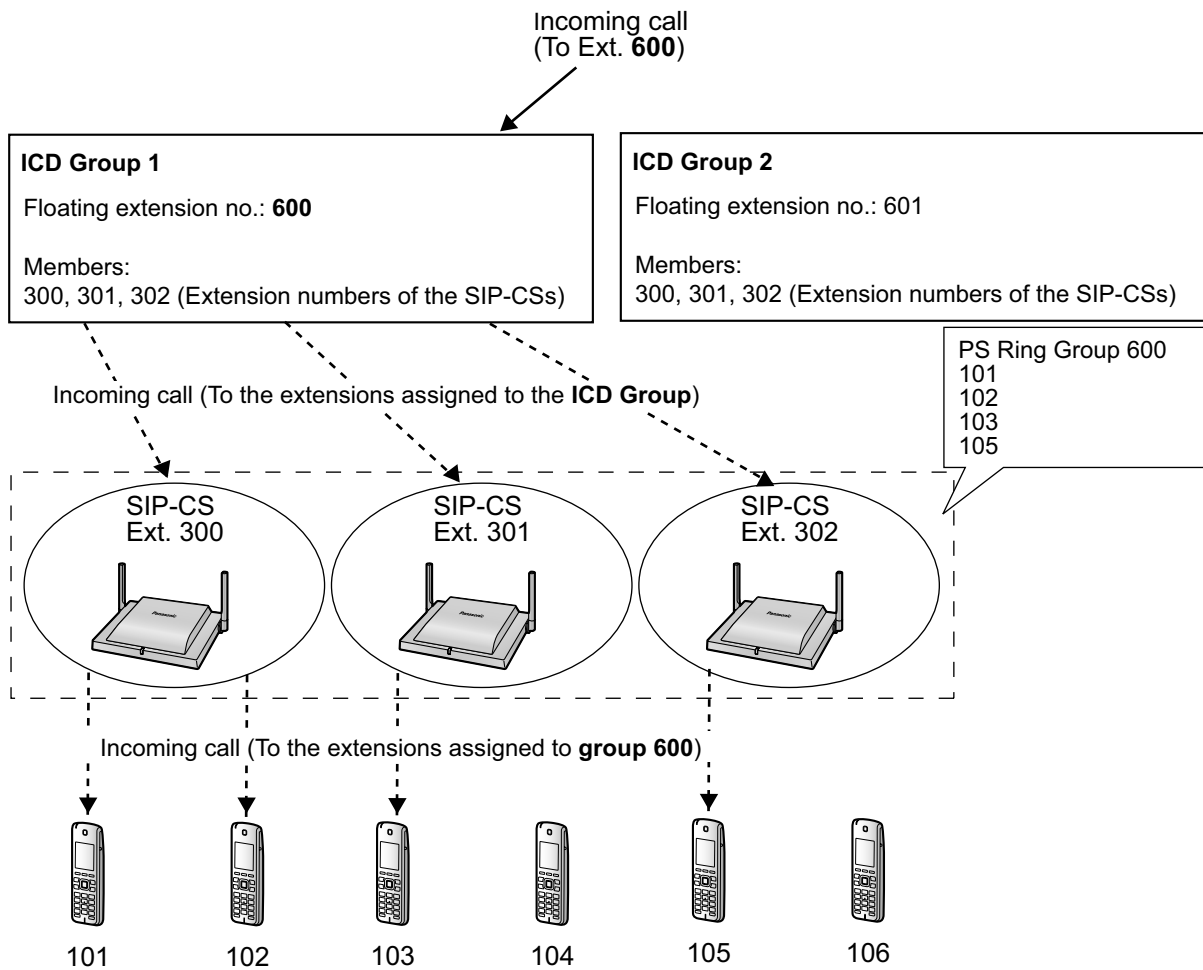

Notice

If an extension number of an S-PS is set directly to the ICD Group, the SIP-CS receives the incoming call as a group call. Therefore, the number of ICD Group members will be restricted since the maximum number of simultaneous calls per SIP-CS is 4.

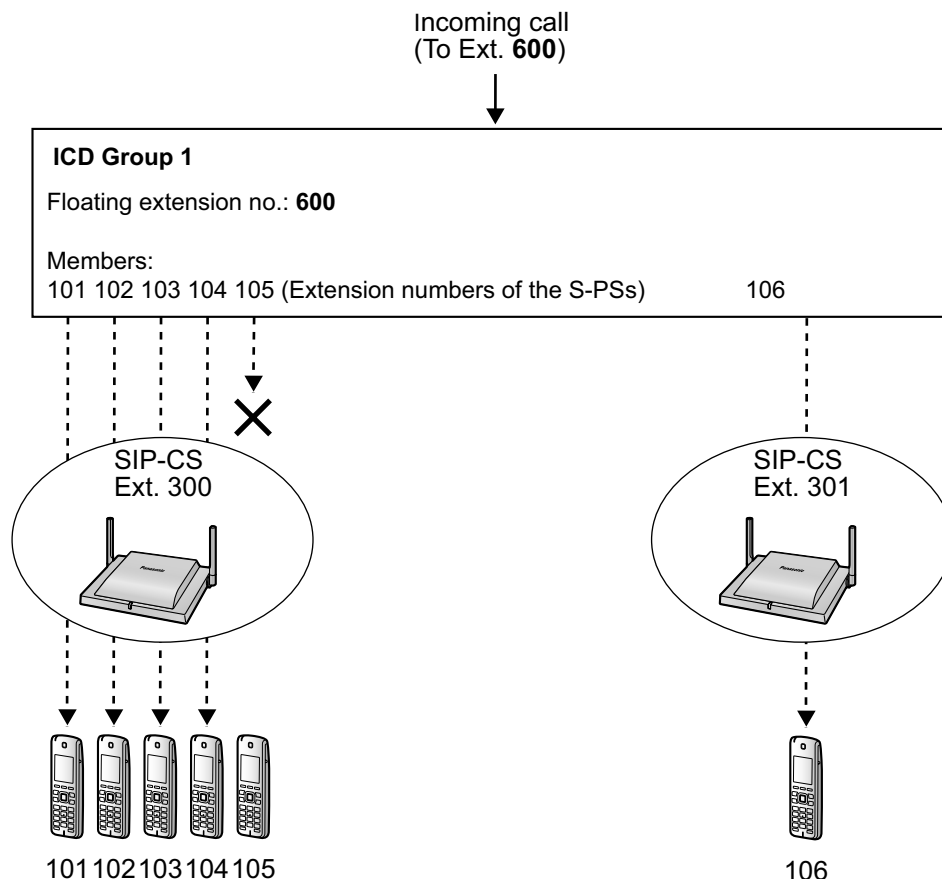

However, if an S-PS is configured as a member of a PS Ring Group of the SIP-CS, the S-PS is able to receive an incoming broadcast call. In this way, incoming calls to S-PSs are not restricted as above.

Programming a PS Ring Group with Web Maintenance Console of the KX-NS1000

Assigning extension number to SIP-CSs

Assign extension numbers to the SIP-CSs. You can follow the same procedure as assigning extension numbers to KX-UT series SIP phones. For details about assigning extensions, refer to the PC Programming Manual of the KX-NS1000.

Programming ICD groups

When the S-PSs that cover the desired area are registered to a SIP-CS, register the extension number of the SIP-CS as a member of the desired ICD groups. For details about the programming, refer to the PC Programming Manual of the KX-NS1000.

Note

To register a SIP-CS to a KX-NS1000, input the extension number and password of the SIP-CS to the KX-NS1000, and then connect the SIP-CS to the LAN. When the extension number and password of the

4 Deployment Procedure

SIP-CS match the one already input in the KX-NS1000's Web Maintenance Console, the SIP-CS will be registered automatically.

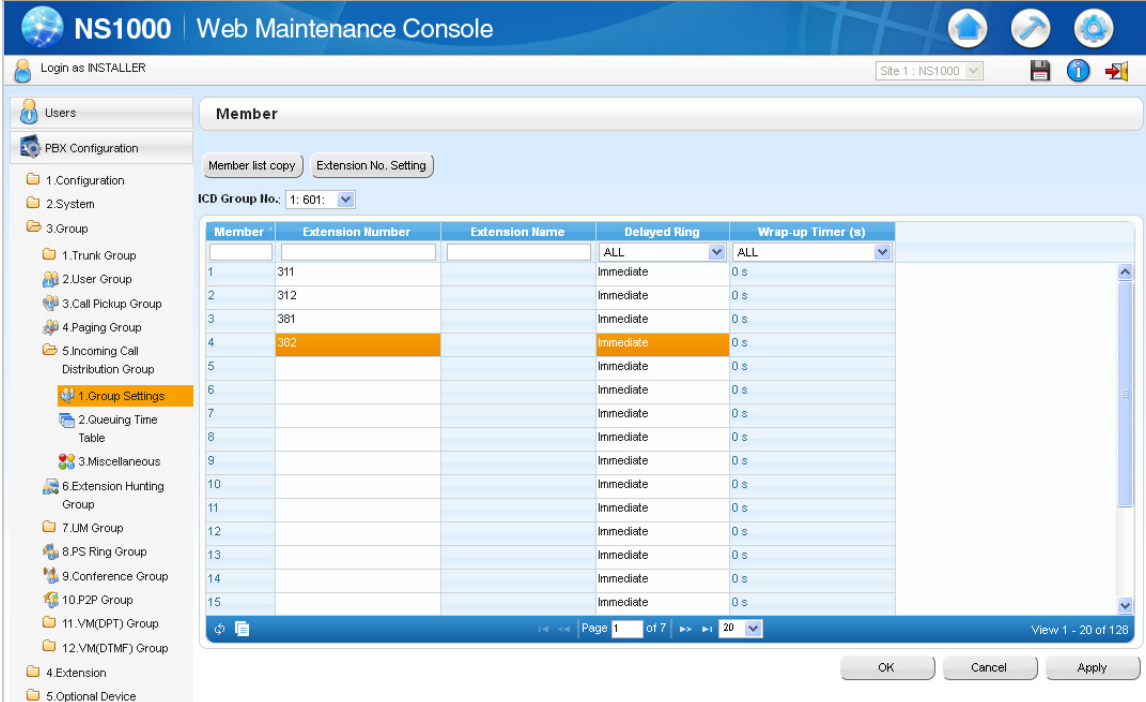

The screenshot displays the NS1000 Web Maintenance Console interface. The left sidebar shows the navigation menu with 'PBX Configuration' expanded to '1. Group Settings'. The main area is titled 'Member' and shows a table of members for ICD Group No. 1: 601. The table has five columns: Member, Extension Number, Extension Name, Delayed Ring, and Wrap-up Timer (s). The data is as follows:

Member	Extension Number	Extension Name	Delayed Ring	Wrap-up Timer (s)
1	311		Immediate	0 s
2	312		Immediate	0 s
3	381		Immediate	0 s
4	382		Immediate	0 s
5			Immediate	0 s
6			Immediate	0 s
7			Immediate	0 s
8			Immediate	0 s
9			Immediate	0 s
10			Immediate	0 s
11			Immediate	0 s
12			Immediate	0 s
13			Immediate	0 s
14			Immediate	0 s
15			Immediate	0 s

The interface includes a 'Member list copy' button, an 'Extension No. Setting' button, and a dropdown for 'ICD Group No.' set to '1: 601'. At the bottom, there are 'OK', 'Cancel', and 'Apply' buttons. The page number is 'Page 1 of 7' and 'View 1 - 20 of 128'.

Programming a PS Ring Group with the Web User Interface of SIP-CSs

Assigning extension number to SIP-CSs

Assign the preconfigured extension number to each SIP-CS that will be a member of the ICD group.

Logging in to a SIP-CS

You can log in to each SIP-CS via the Web user interface of the Super Master CS.

1. In the **System** tab, select **CS Management**.

- Click **Login** for the corresponding SIP-CS, in **CS Registered List**.

Panasonic

SIP CS KX-UDS124 Status Network **System** VoIP Telephone Maintenance

Web Logout
Web Port Close

CS Management

System

- Web Language
- Administrator Password
- Change User Password
- Web Server Settings
- Time Setting
- Time Adjust Settings
- CS Name
- Air Settings
- CS Management
- Tree Survey
- CS Monitor
- PS Registration
- PS Settings

CS Registration

Air Sync Group: 1
Number of CS: 32
Start CS Registration
Stop CS Registration
Only CS that has a check in the check box can be deleted.
CS Registration Delete: Delete CS Registration

CS Registered List

All

No.	Index	CS Name CS ID	MAC Address IP Address	CS Class	Remote Login
1	1	01973103D0	00.80.F0.E9.74.40 192.168.0.103	Master	
2	2	0018E58900	00.80.F0.AC.67.44 192.168.0.142	Slave	Login
3					
4					
5					

Assigning an extension number to a SIP-CS

Follow the procedure below to assign the extension number to the SIP-CS you are logged in to.

- In the **VoIP** tab, select **SIP Settings - CS**.
- Enter the SIP-CS's extension number in **Phone Number**.
- Enter the SIP-CS's extension number again in **Authentication ID**.
- Enter a password in **Authentication Password**.
- Click **Save**.

Panasonic

SIP CS KX-UDS124 Status Network System **VoIP** Telephone Maintenance

Web Logout
Web Port Close

SIP Settings - CS

VoIP

- SIP Settings - CS
- SIP Settings - PS

CS Name

CS Name: SIP-CS01
MAC Address: 0080F0AC6779

Phone Number

Phone Number: 300
SIP URI:

SIP Authentication

Authentication ID: 300
Authentication Password: ****

Save Cancel

Programming a PS Ring Group of the SIP-CS

Assign the desired S-PSs to a PS Ring Group of the SIP-CS. This setting can be performed only on the Web user interface of the Super Master CS.

4 Deployment Procedure

1. In the **Telephone** tab, click **PS Ring Group Settings**.
2. Click **PS Group xx Registration** for the group you want to programme.
3. Select the S-PSs to be registered in **Available Users**, and then click . To select all available S-PSs, click . To deselect S-PS(s), click or .
4. Click **All Save**.
The changes are sent to all SIP-CSs.

The image displays two screenshots of the Panasonic SIP CS KX-UDS124 web interface, illustrating the configuration steps for PS Ring Group Settings.

Left Screenshot: PS Ring Group Settings - Group Registration List

Group Index	Group Number	Select Button
1	600	Ring Group1 Registration
2	601	Ring Group2 Registration
3		Ring Group3 Registration
4		Ring Group4 Registration
5		Ring Group5 Registration
6		Ring Group6 Registration
7		Ring Group7 Registration
8		Ring Group8 Registration
9		Ring Group9 Registration
10		Ring Group10 Registration
11		Ring Group11 Registration
12		Ring Group12 Registration

Right Screenshot: PS Ring Group Settings - Group Member Registration

Group Name / Number Registration
Group Number: 600

Group Member Registration

Available Users	Group Members
1 1001	

Buttons: >>, >, <, <<, All Save, Cancel

4.10 Configuration and PS Registration (for a system using a third party SIP server)

4.10.1 Programming SIP-CSs for a Third Party SIP Server Specifying the SIP Server's Information

Panasonic
SIP CS KX-UDS124

Status | Network | System | **VoIP** | Telephone | Maintenance

Web Logout
Web Port Close

SIP Settings

VoIP
SIP Settings
SIP Settings - PS
VoIP Settings

SIP Setting
SIP User Agent: Panasonic_(MODEL)/(f/wer) ((mac))

SIP Server
Registrar Server Address: 192.168.0.10
Registrar Server Port: 5060 [1-65535]
Proxy Server Address: 192.168.0.10
Proxy Server Port: 5060 [1-65535]
Presence Server Address:
Presence Server Port: 5060 [1-65535]

Outbound Proxy Server
Outbound Proxy Server Address:
Outbound Proxy Server Port: 5060 [1-65535]

SIP Service Domain
Service Domain:

DNS
Enable DNS SRV lookup: Yes No
SRV lookup Prefix for UDP: _sip_udp.
SRV lookup Prefix for TCP: _sip_tcp.

Transport Protocol for SIP
Transport Protocol: UDP TCP

Timer Settings
T1 Timer: 500 milliseconds
T2 Timer: 4 seconds
Timer B: 32000 milliseconds [250-64000]

Follow the procedure below to specify the IP address and port number of the SIP server to which the Super Master CS is connected.

1. In the **VoIP** tab, select **SIP Settings**.
2. In **Registrar Server Address**, enter IP address of the SIP Registrar server.
3. In **Registrar Server Port**, enter the port number of the SIP Registrar server that is set to communicate with the SIP-CS.
4. In **Proxy Server Address**, enter the IP address of the SIP Proxy server.
5. In **Proxy Server Port**, enter the port number of the SIP Proxy server that is set to communicate with the SIP-CS.
6. Click **All Save**.

Specifying the Preferred Codec

Panasonic

SIP CS KX-UDS124 Status Network System **VoIP** Telephone Maintenance

Web Logout

Web Port Close

VoIP Settings

VoIP

- SIP Settings
- SIP Settings - PS
- VoIP Settings**

RTP Settings

RTP Packet Time	20	milliseconds
Minimum RTP Port Number	16000	[1024-48750: Even Number Only]
Maximum RTP Port Number	20000	[1424-49150: Even Number Only]
Telephone-event Payload Type	101	[96-127]

Quality of Service (QoS)

RTP Packet QoS (DSCP)	0	[0-63]
-----------------------	---	--------

Statistical Information

RTCP Enable	<input type="radio"/> Yes <input checked="" type="radio"/> No	
RTCP Interval	5	seconds [5-65535]

Jitter Buffer

Maximum Delay	20	[3-50]
Minimum Delay	2	[1-2]
Initial Delay	2	[1-7]

DTMF

DTMF Type	<input checked="" type="radio"/> Outband <input type="radio"/> Inband
-----------	---

Call Hold

Supports RFC 2543 (c=0.0.0.0)	<input checked="" type="radio"/> Yes <input type="radio"/> No
-------------------------------	---

CODEC Preferences

G722	Enable	<input checked="" type="radio"/> Yes <input type="radio"/> No
	Priority	1
PCMA	Enable	<input checked="" type="radio"/> Yes <input type="radio"/> No
	Priority	1
G726-32	Enable	<input checked="" type="radio"/> Yes <input type="radio"/> No
	Priority	1

Follow the procedure below to specify the codecs you want to use and their usage priorities.

1. In the **VoIP** tab, select **VoIP Settings**.
2. In **CODEC Preferences**, select a codec to use and specify its priority.
3. Click **All Save**.

4.10.2 PS Registration

This section shows how to register S-PS by using Web user interface.

Log in to the Web User Interface of the Super Master CS

Please refer to "Logging in to the Web User Interface" in "4.6 Basic Network Configuration" for entering Web user interface.

Registering Extension Numbers and Extension Names for S-PSs

Follow the procedure below to assign extension numbers and extension names to the S-PSs.

Panasonic

SIP CS KX-UDS124 Status Network **System** VoIP Telephone Maintenance

Web Logout
Web Port Close

System

- Web Language
- Administrator Password
- Change User Password
- Web Server Settings
- Time Setting
- Time Adjust Settings
- CS Name
- Air Settings
- CS Management
- Tree Survey
- CS Monitor
- PS Registration
- PS Settings

PS Registration

Please push the "Stop PS Registration" button to stop on the way after starting PS Registration.

PS Registration Start PS Registration
Stop PS Registration

Please push the "Delete PS Registration" to delete registered PS.

PS Registration Delete Delete PS Registration

1- 21- 41- 61- 81- 101- 121- 141- 161- 181- 201- 221- 241-

PS Name / Number

No.	PS Name	Select Button	Phone Number	Wireless Status
1	<input type="text"/>	Line1 SIP Setting Line2 SIP Setting		Un Registered
2	<input type="text"/>	Line1 SIP Setting Line2 SIP Setting		Un Registered
3	<input type="text"/>	Line1 SIP Setting Line2 SIP Setting		Un Registered
		Line1 SIP Setting		Un Registered

1. In the **System** tab, select **PS Registration**.
2. Enter an extension name in **PS Name**.
3. Click **All Save**.
4. Select **Line 1 SIP Setting** or **Line 2 SIP Setting**.

Note

Some SIP servers allow only 1 extension number per telephone. For details, refer your SIP server's documentation.

Panasonic

SIP CS KX-UDS124 Status Network **System** VoIP Telephone Maintenance

Web Logout
Web Port Close

System

- Web Language
- Administrator Password
- Change User Password
- Web Server Settings
- Time Setting
- Time Adjust Settings
- CS Name
- Air Settings
- CS Management
- Tree Survey
- CS Monitor
- PS Registration
- PS Settings

SIP Settings - PS [Line 1] Back

PS Name

PS Name

Phone Number

Phone Number

SIP URI

SIP Authentication

Authentication ID

Authentication Password

SIP Source Port

Source Port [1024-49151]

All Save Cancel

4 Deployment Procedure

5. Enter the **Phone Number**, and enter **Authentication ID** and **Authentication Password** if necessary.
6. Click **All Save**.
7. Click **Back**.
8. Repeat steps 2 to 7 for each S-PS.

Note

If the S-PS name is too long to display, the end of the name may not be displayed on the S-PS's standby screen.

Starting Registration Mode

After you have configured the S-PS name and SIP settings, follow the procedure below to register S-PSs.

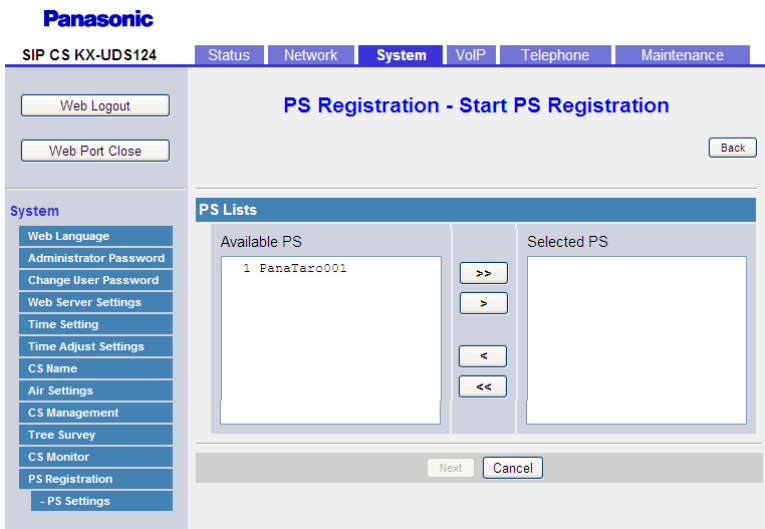

1. In the **System** tab, select **PS Registration** → **Start PS Registration**.
2. Select the S-PSs to be registered in **Available PS**, and then click . To select all available S-PSs, click . To deselect S-PS(s), click or .
3. Click **Next**.
4. Click **OK** to confirm registration.

Registering S-PSs

After entering PS Registration mode, follow the procedure below to register each S-PS.

For unregistered S-PS

1. Display the standby screen below.



*1 The symbol for the centre soft key (Menu) differs depending on the country/area.

2. Hold down **OK** until "Please wait..." is displayed.

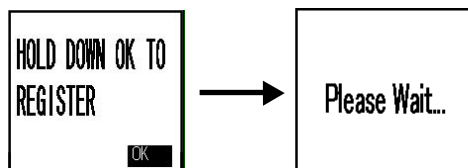

3. When registration has completed, "Registered" will be displayed.

**Note**

- You can register multiple S-PSs continuously. However, PS Registration mode will terminate if no registrations are detected within 2 minutes (If the IPEI is registered by provisioning, there is no time limit.). All SIP-CSs controlled by the Super Master CS will enter PS Registration mode at the same time as the Super Master CS. You can register an S-PS to any of the SIP-CSs.
- When registering multiple S-PSs, perform the registration procedure on each S-PS individually. Performing the registration procedure on multiple S-PSs at the same time may result in an error. In this case, reperform the registration procedure.
- After registering S-PSs, the Web port will be closed. Refer to the Administrator Guide to open the Web port again.
- After registering S-PSs, S-PS firmware update may start automatically. During the firmware update, the S-PS may reboot up to 3 times. Therefore, you should not remove the battery/batteries of the S-PS.

For registered S-PS

Please refer to "5.1 PS Registration from Web User Interface—Registering S-PSs—For registered S-PSs" in the Administrator Guide.

Checking Progress

You can check registration progress on the **PS Registration** screen.

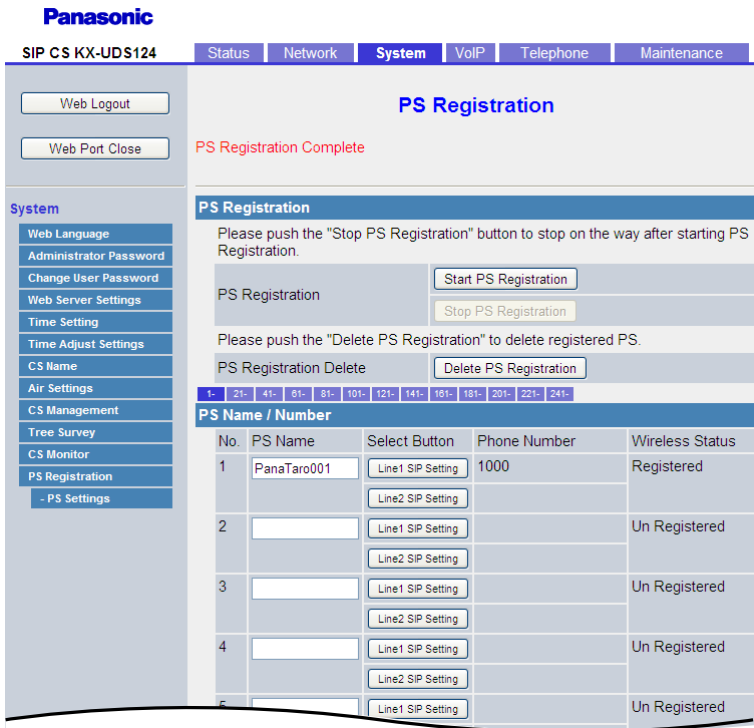

If **Trying** is displayed on the left of the screen, you can check the registration status of each S-PS in the **Wireless Status** field.

If **PS Registration Complete** is displayed on the left of the screen, all S-PSs that selected for registration were registered successfully.

Unregistering S-PSs

If you want to unregister a specified S-PS, follow the procedure below.

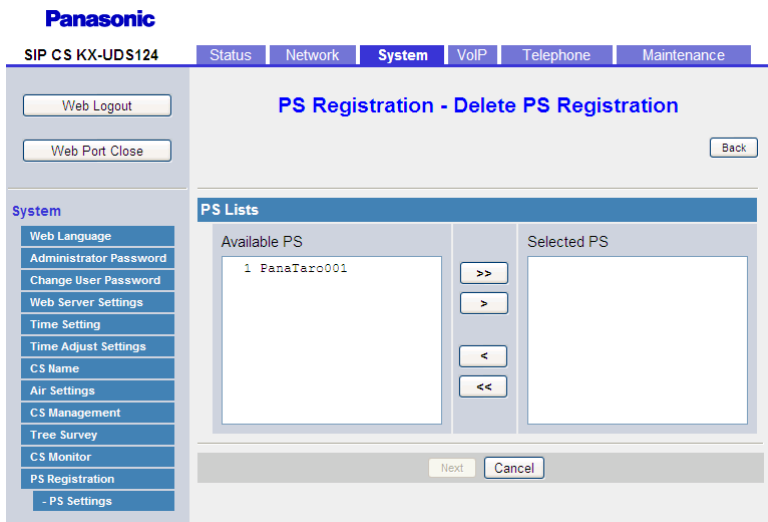

1. In the **System** tab, select **PS Registration** → **Delete PS Registration**.
2. Select the S-PSs to be unregistered in **Available PS**, and then click . To select all available S-PSs, click . To deselect S-PS(s), click or .
3. Click **Next**.
4. Click **OK** to confirm unregistration.

Unregistering a Base System from the S-PS

If the S-PS was outside the coverage area or was turned off when the above-mentioned unregistration procedure was performed, you must unregister the base system manually.

1. Enter the "Setting Handset" menu.
2. Select "System Option" and then press **OK**.

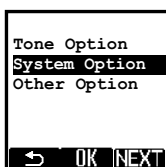

3. Select "Cancel Base" and then press **OK**.

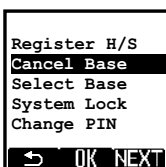

4. Select the base number for unregistration by pressing , and then press **OK**.

Note

You can select multiple base numbers for unregistration if necessary.

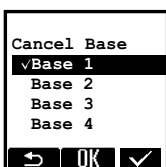

5. Select "Yes" and then press **OK**.



When unregistration has completed, "Deleted" will be displayed.

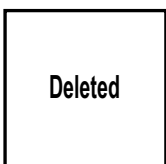

4.11 How to back up and restore configuration data

It is recommended to keep a backup of Super Master CS configuration data.

The backup data is useful when restoring the same configuration data to the Super Master CS when it must be re-installed due to a hardware error, etc.

For details, please refer to the Administrator Guide.

4.12 PS Area Check

In this section, you can check the service area, handover and voice quality using 2 registered S-PSs under actual conditions.

Entering S-PS Area Check mode

1. Start the S-PS in Maintenance mode.
For details, see "Starting the S-PS in Maintenance Mode" in "4.3 Site Survey".
2. Select "PS area check", and then press **OK**.
3. Select "on".
4. Press **OK**.
5. Press the POWER key until the S-PS is turned off to exit Maintenance mode.
6. Press the POWER key until the S-PS is turned on.
7. Repeat the procedure from 1 to 6 for another S-PS.

Note

Both S-PSs must be in PS Area check mode.

Conducting S-PS Area Check

1. Call S-PS(2) from S-PS(1) to call the registered phone number via PS Registration.
S-PS(1) sends a tone signal to S-PS(2), and S-PS(2) returns the signal back to S-PS(1).
You can hear a tone when this signal is received.
2. Set S-PS(2) close to the SIP-CS and move around the service area listening to the tone from S-PS(1)'s receiver to confirm voice quality and handover operation.
The CS-ID and signal strength of the SIP-CS you are connected to and the target SIP-CS for Handover is displayed on the S-PS. When the signal strength is sufficiently strong, the CS-ID is displayed in green.

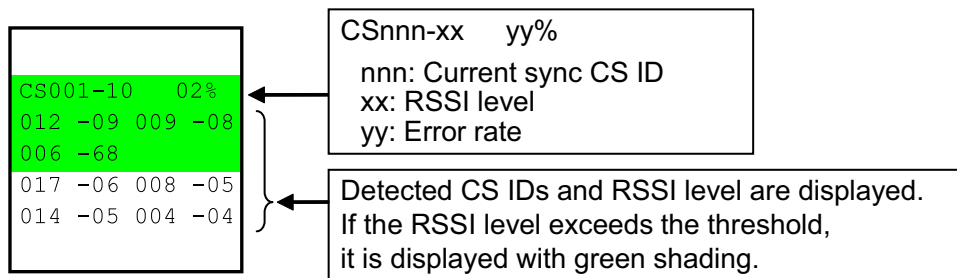

Notice

When checking the PS area, ensure that at least one SIP-CS is displayed in green on the LCD of the handset within the service area.

Note

For information about the numbers displayed on this LCD screen, refer to the tables and example image shown in "Site Survey for S-PS Service Area" in "4.3 Site Survey".

Notes for Conducting S-PS Area Check

When you conduct PS area checking, please note the following:

- In order to perform handover for S-PSs, at least two SIP-CSs need to be recognised by the S-PSs in the service area.

4 Deployment Procedure

- SIP-CSs with a signal strength that is sufficiently strong but that are not currently connected are also displayed in green on the S-PS's LCD screen.
- When the S-PS moves towards another SIP-CS, the RSSI level of the currently connected SIP-CS changes.
- Handover is performed when the RSSI level of the currently connected SIP-CS becomes lower than the other SIP-CS's RSSI level.
- Make sure to check that there is no noise during handover.

Exiting S-PS Area Check Mode

When the S-PS area check is finished, exit the S-PS area check mode.

1. Start the S-PS in Maintenance mode.
For details, see "Starting the S-PS in Maintenance Mode" in "4.3 Site Survey".
2. Select "**PS area check**", and then press **OK**.
3. Select "**off**".
4. Press **OK**.
5. Press the POWER key until the S-PS is turned off.
6. Press the POWER key until the S-PS is turned on.
7. Repeat the procedure from **1** to **6** for the other S-PS.

5 Troubleshooting

This section provides information on SIP-CS and S-PS troubleshooting.

When the KX-NS1000 is also used with SIP-CSs and S-PSs, refer to this section and troubleshooting section of the KX-NS1000's Installation Manual.

CS Registration Notices

When you cannot register any SIP-CSs, the cause may be one of the following:

In the case of Air Sync Group 1

- Slave CSs have no power.
- Slave CSs have network trouble (LAN cable disconnection, SIP-CS cannot obtain an IP address from the DHCP server, and so on).

In the case of Air Sync Groups 2–8

- Air Sync Master CS has no power.
- Air Sync Master CS does not exist.
- Air Sync Master CS is not connected to the network.
- Air Sync Master CS has network trouble (LAN cable disconnection, SIP-CS cannot obtain an IP address from the DHCP server, and so on).
- Slave CSs have no power.
- Slave CSs have network trouble (LAN cable disconnection, SIP-CS cannot obtain an IP address from the DHCP server, and so on).

Tree Survey Error Messages and Notices

When an error occurs during or after the Tree Survey, an error message or notice is displayed.

Messages displayed during the Tree Survey

Message	Probable Cause	Solution
Tree Survey Timeout	<ul style="list-style-type: none"> • Slave CS may have network trouble. • Slave CS cannot receive radio signal from another Air Sync Group CS. 	<ul style="list-style-type: none"> • Please check the SIP-CS's power/network condition. • Please check whether a radio signal obstacle, such as a metal shelf, a door, etc., exists near the SIP-CS.
CS Number Error.	<ul style="list-style-type: none"> • There are no SIP-CSs (or only one SIP-CS) in the Air Sync Group. 	Before conducting the Tree Survey, please register SIP-CSs.

Messages displayed when the Tree Survey is complete

Message	Probable Cause	Solution
Notice: CS does not have Secondary CS.	One or more SIP-CSs could not have a Slave CS assigned for reasons such as avoiding the creation of a loop. However, this is not a problem.	Please move the SIP-CS(s) closer to the adjacent SIP-CS according to site planning. Loops may occur when SIP-CSs are assigned as a Slave CS. In this case, please reconduct site planning.

Message	Probable Cause	Solution
ERROR!!! CS does not have Primary CS.	A SIP-CS has radio signal trouble.	Please check whether a radio signal obstacle, such as a metal shelf, a door, etc., exists near the SIP-CS.
ERROR!!! Unknown error code.	Tree Survey failed for some reason.	Conduct the Tree Survey again.

PS Registration Notices

When you cannot register any S-PSs, the cause may be one of the following:

When you hear the error alarm (beep):

- The Super Master CS has no power supply.
- The distance between the S-PS and the SIP-CS is too far.
- PS Registration mode of the SIP-CS did not start or was timed out.

Note

For more information about registering the S-PS, refer to the documentation for the S-PS.

- 32 S-PSs are already registered.

Note

- You can register up to 32 S-PSs to one SIP-CS by default.
If you want to register an S-PS to a SIP-CS which already has 32 S-PSs registered, re-register some S-PSs to other SIP-CSs before the registration.
If you want to change the maximum number of S-PSs per SIP-CS, refer to the Administrator Guide.
- When a KX-NS1000 is used with SIP-CSs and S-PSs, you can register up to 255 S-PSs.

6 Appendix

6.1 Specifications

SIP-CS Specification

Type	4 channel CS with wideband audio
Supported Audio	Wideband Narrowband
Radio Method	DECT
VoIP Signalling Protocol	SIP
IP Port Number Flexible Setting	Yes
Local Setting	Yes (through Web application)
Site Survey Mode	Yes
Initialisation	Yes
Maximum Simultaneous Calls	4
Power Supply	PoE (IEEE 802.3af Class1) Optional AC adaptor (KX-A239CE [PQLV206CE]/KX-A239UK [PQLV206E]/ KX-A239BX [PQLV206CE]/KX-A239EJ [PQLV206E]/ KX-A239AL [PQLV206AL])
VoIP Audio Codec	G.722, G.711, G.729A, G.726
LAN Port	10 BASE-T 100 BASE-TX
VLAN	Yes (802.1Q)
IP Addressing	DHCP Static IP Address Setting
Software Upgrade	Yes
Built-in VPN	No
Weight	290 g
Size	(W) 190 mm × (H) 133.9 mm × (D) 39.3 mm

PS Specification

Items	KX-UDT111	KX-UDT121	KX-UDT131
Type	Standard	Slim & Light	Tough
Radio Method	DECT		

Items	KX-UDT111	KX-UDT121	KX-UDT131
LCD	1.8 inch colour		
Bluetooth	No	Yes	
Vibration	Yes		
Battery	Ni-MH	Li-Ion	
Number of Simultaneous Registered Systems	4		
Software Upgrade	Yes (Wireless Download)		

RF Specification

Item	Description
Radio Access Method	MultiCarrier TDMA-TDD
Frequency Band	1880 MHz to 1900 MHz
Number of Carriers	10
Carrier Spacing	1728 kHz
Transmission Output	Peak 250 mW

CAUTION

- The SIP-CS should be kept free of dust, moisture, high temperature (more than 40 °C), low temperature (less than 0 °C), and vibration, and should not be exposed to direct sunlight.
- The SIP-CS should not be placed outdoors (use indoors).
- The SIP-CS should not be placed near high-voltage equipment.
- The SIP-CS should not be placed on a metal object.

Compatible S-PSs

Item	Model No.
S-PS	<ul style="list-style-type: none"> • KX-UDT111 • KX-UDT121 • KX-UDT131

Note

- For more details about S-PSs, refer to the documentation for your S-PS.

AC Adaptor

The following table lists available AC adaptors. Note which AC adaptor is used for each model by the suffix ("CE", "BX", etc.) following "KX-A239".

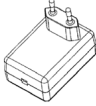
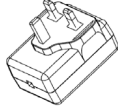
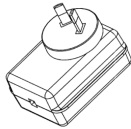
Model No.	Part No.	Type
KX-A239CE	PQLV206CE	
KX-A239BX		
KX-A239UK	PQLV206E	
KX-A239EJ		
KX-A239AL	PQLV206AL	

CE 0470

Panasonic System Networks Co., Ltd. declares that the KX-UDS124CE is in compliance with the essential requirements and other relevant provisions of Radio & Telecommunications Terminal Equipment (R&TTE) Directive 1999/5/EC.

Declarations of Conformity for the relevant Panasonic products described in this manual are available for download by visiting:

<http://www.doc.panasonic.de>

Contact to Authorised Representative:
Panasonic Testing Centre
Panasonic Marketing Europe GmbH
Winsbergring 15, 22525 Hamburg, Germany

Panasonic System Networks Co., Ltd.

1-62, 4-chome, Minoshima, Hakata-ku, Fukuoka 812-8531, Japan
Web Site: <http://www.panasonic.net/>

Copyright:

This material is copyrighted by Panasonic System Networks Co., Ltd., and may be reproduced for internal use only. All other reproduction, in whole or in part, is prohibited without the written consent of Panasonic System Networks Co., Ltd.

© Panasonic System Networks Co., Ltd. 2012