

Panasonic[®]

Operating Instructions DECT Portable Station

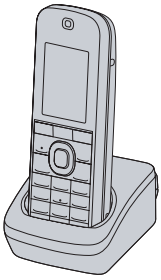

Model No. **KX-UDT121**

Thank you for purchasing this Panasonic product.

Please read this manual carefully before using this product and save this manual for future use.

Please use only the battery provided and charge the battery for about 3 hours before using the handset for the first time. For details, see "Charging the Battery" in this manual.

Note

In this manual, the suffix of each model number is omitted unless necessary.

Introduction

Outline

This manual describes information about the installation and operation of the PS (Portable Station) handset and the charger.

Related Documentation

Getting Started

Briefly describes basic information about the installation of the handset and the charger.

Administrator Guide

Describes information about the programming and maintenance of the SIP Cell Station Unit (CS).

Installation Guide

Briefly describes basic information about the installation of the SIP Cell Station Unit (CS).

Manuals and supporting information are provided on the Panasonic Web site at:

<http://panasonic.net/pcc/support/sipphone>

Note

- The contents and design of the software are subject to change without notice.

Other Information

For Future Reference

Record the information in the space below for future reference.

Note

- The serial number of this product may be found on the label affixed to the inside of the battery compartment on the back of the handset. You should note the serial number of this unit in the space provided and retain this manual as a permanent record of your purchase to aid in identification in the event of theft.

MODEL NO.	_____
SERIAL NO.	_____
DATE OF PURCHASE	_____
NAME OF DEALER	_____
DEALER'S ADDRESS	_____ _____ _____
DEALER'S TEL. NO.	_____

Trademarks

- The Bluetooth® word mark and logos are owned by the Bluetooth SIG, Inc. and any use of such marks by Panasonic Corporation is under licence.
- Jabra is a registered trademark of GN Netcom A/S.
- Plantronics is a registered trademark of Plantronics, Inc.
- vCard is a trademark of the Internet Mail Consortium.
- All other trademarks identified herein are the property of their respective owners.

Table of Contents

Important Information	6
For Your Safety	6
Data Security	8
Additional Information	9
Important Safety Instructions	9
For Best Performance	11
Battery Information	12
Before Operating the Telephone	14
Accessory Information	14
Location of Controls	15
Handset Functions	17
Setting the Password	17
Key Lock	17
Silent Mode	17
Noise Reduction	18
Power Save Mode	18
Display	19
Soft Keys	20
Other Icons	21
Flexible Keys	22
Basic Operations	23
Operation Outline	23
Function Menus	24
Function Keys	24
Selecting the Display Language	25
Changing the Handset Phone Number Display	25
Editing the Names of the Flexible Keys	25
Adjusting the Ringer Volume	25
Changing the Vibrate Setting	25
Adjusting the Receiver/Speaker/Headset Volume	26
Feature Operations	27
Making Calls	27
Calling	27
One-touch Dialling	27
Hot Key Dialling	27
Searching for an Item in the Phonebook	28
Receiving Calls	29
Receiving	29
Caller ID	29
During a Conversation	30
Holding a Call	30
Transferring a Call (Call Transfer)	30
Three-party Conference	31
Useful Features	32
Call Forwarding/Do Not Disturb	32
Call Waiting	32
Listening to Voice Mail Messages	32
Bluetooth	32
Turning Bluetooth On or Off	32
Setting and Changing the Bluetooth PIN Number	33

Registering and Deregistering the Bluetooth Headset	33
Connecting and Disconnecting a Bluetooth Headset	34
Call Handling with a Bluetooth Headset	34
Registering and Deregistering a Cell Phone for Phonebook Transfer	35
Customising the Telephone	36
Using the Handset Phonebook	36
Private Ring	36
Storing an Item in the Handset Phonebook	36
Locking the Handset Phonebook	38
Phonebook and vCard Transfer by Bluetooth	38
Assigning Hot Keys	40
Memo Alarm Setting	40
Entering Characters	42
Character Mode Table	43
Deleting Stored Items	44
Changing Handset Settings	45
Handset Setting Menu Layout	45
Installation and Setup	54
Battery Installation	54
Charger Connection	54
Charging the Battery	55
Charger Wall Mounting	55
Attaching the Belt Clip	56
Attaching the Phone Strap	56
Appendix	57
Specifications	57
RF Specifications (DECT)	57
RF Specifications (Bluetooth)	57
Troubleshooting	58
Error Messages	62
Index.....	64



Important Information

For Your Safety



To reduce the risk of injury, loss of life, electric shock, fire, malfunction, and damage to equipment or property, always observe the following safety precautions.

Explanation of symbols

The following symbols are used to classify and describe the level of hazard and injury caused when the denotation is disregarded and improper use is performed.









	WARNING
Denotes a potential hazard that could result in serious injury or death.	
	CAUTION
Denotes a hazard that could result in minor injury or damage to the unit or other equipment.	





The following symbols are used to classify and describe the type of instructions to be observed.

	This symbol is used to alert users to a specific operating procedure that must not be performed.
	This symbol is used to alert users to a specific operating procedure that must be followed in order to operate the unit safely.





WARNING

General Safety

-  For safety reasons, do not physically modify the product or any optional equipment.
-  To prevent possible fire or electric shock, do not expose this product to rain or moisture.
-  Follow all warnings and instructions marked on this product.
-  To reduce the risk of electric shock, do not disassemble this product. Only qualified personnel should service this product. Opening or removing covers may expose you to dangerous voltages or other risks. Incorrect reassembly can cause electric shock.
-  Unplug the AC adaptor from the AC outlet and have the product serviced by qualified service personnel in the following cases:
 - A.** When the power supply cord or plug is damaged or frayed.
 - B.** If liquid has been spilled into this product.
 - C.** If the product has been exposed to rain or water.
 - D.** If the product does not operate according to this manual. Adjust only the controls that are explained in this manual. Improper adjustment of other controls may result in damage and may require service by a qualified technician to restore the product to normal operation.
 - E.** If the product has been dropped or damaged.
 - F.** If product performance deteriorates.
-  Do not insert objects of any kind into this product through openings, as they may touch dangerous voltage points or short out parts that could result in a risk of fire or electric shock. Never spill liquid of any kind on or in the product.
-  The use of excessive sound volume through earphones, headphones, or headsets may cause hearing loss.
-  Switch off the device when in the proximity of areas with potentially explosive atmospheres such as fuel/chemical storage facilities or blasting operations.

-  Consult the manufacturer of any personal medical devices, such as pacemakers, to determine if they are adequately shielded from external RF (radio frequency) energy. (The product operates in the frequency range of 1880 MHz to 1900 MHz and the output peak power level is less than 0.25 W. When using Bluetooth® devices, the product operates in the frequency range of 2.4000 GHz to 2.4835 GHz and the output peak power level is less than 2.5 mW.)
-  Do not use the product in health care facilities if any regulations posted in the area instruct you not to do so. Hospitals or health care facilities may be using devices sensitive to external RF (radio frequency) energy.
-  Unplug the charger from AC outlet if it emits smoke, an abnormal smell or makes unusual noise. These conditions can cause fire or electric shock. Confirm that smoke has stopped and contact an authorised service centre.
-  The battery poses a choking hazard. Keep the battery out of reach of children.
-  This handset earpiece is magnetised and may retain small ferrous objects.













Installation

-  Do not install the product in any other way than described in relevant manuals.
-  The product may only be installed and serviced by qualified service personnel.
-  The AC adaptor should only be connected to the type of electric power supply specified on the charger label. If you are not sure of the type of power supply to your home, consult your dealer or local power company.
-  Do not allow anything to rest on the power cord. Do not locate the charger where the power cord may be stepped on or tripped on.

Placement

-  Do not place the product on an unstable surface, as a fall may cause serious internal damage.



-  The AC adaptor is used as the main disconnect device. Ensure that the AC outlet is installed near the product and is easily accessible.
-  The product should never be placed near or over a radiator or other heat source.
-  Use only the AC adaptor, battery and charger indicated in this manual.
-  Do not dispose of the battery in a fire. It may explode. Check with local authorities for special disposal instructions.
-  Do not open, puncture, crush, or drop the battery. A damaged battery must not be used. This can result in the risk of fire, explosion, overheating, and leaking of the electrolyte.
-  Do not touch released electrolyte if the battery leaks. It may cause burns or injury to the eyes or skin. The electrolyte is toxic and may be harmful if swallowed. If you touch it, immediately wash the affected areas with water and seek medical help.
-  Exercise care in handling the battery in order not to short the battery to conductive materials such as rings, bracelets, and keys. The battery and/or conductor may overheat and cause burns.
-  Charge the battery provided with, or identified for use with, this product only in accordance with the instructions and limitations specified in this manual.
-  There is a danger of explosion if the battery is incorrectly replaced.
-  When you leave the product unused for a long period of time, unplug the AC adaptor from the outlet.
-  Do not use a microwave oven to dry this product.
-  Do not use the AC adaptor if it has been submerged in water.

Notice

- This telephone communicates using digital signals that are difficult to intercept. However, it is possible that the signals could be intercepted by a third party.

Data Security

- To avoid unauthorised access to this product:
 - Keep the password (e.g., PIN for registration) secret.
 - Change the default password.
 - Set a password that is random and cannot be easily guessed.
 - Change the password regularly.
- This product can store your private/confidential information. To protect your privacy/confidentiality, we recommend that you erase the information such as the phonebook or call log from the memory before you dispose of, transfer or return the product, or have the product repaired.
- Set the password when you register the PS to the CS (Cell Station). For details, see "Setting the Password (Page 17)".
- It is recommended that you lock the phonebook to prevent stored information from being leaked when you carry the PS or if the PS is lost.

Additional Information

Important Safety Instructions

When using your telephone equipment, basic safety precautions, including those below, should always be followed to reduce the risk of fire, electric shock and injury to persons.

- Do not use the product near water, for example, near a bathtub, wash bowl, kitchen sink, or laundry tub, in a wet basement, or near a swimming pool.
- Do not use the telephone in the vicinity of a gas leak to report the leak.

SAVE THESE INSTRUCTIONS

Information for Users on Collection and Disposal of Old Equipment and used Batteries

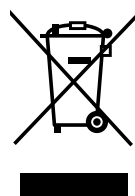

These symbols on the products, packaging, and/or accompanying documents mean that used electrical and electronic products and batteries should not be mixed with general household waste.

For proper treatment, recovery and recycling of old products and used batteries, please take them to applicable collection points, in accordance with your national legislation and the Directives 2002/96/EC and 2006/66/EC.

By disposing of these products and batteries correctly, you will help to save valuable resources and prevent any potential negative effects on human health and the environment which could otherwise arise from inappropriate waste handling.

For more information about collection and recycling of old products and batteries, please contact your local municipality, your waste disposal service or the point of sale where you purchased the items.

Penalties may be applicable for incorrect disposal of this waste, in accordance with national legislation.

For business users in the European Union

If you wish to discard electrical and electronic equipment, please contact your dealer or supplier for further information.



Information on Disposal in other Countries outside the European Union

These symbols are only valid in the European Union. If you wish to discard these items, please contact your local authorities or dealer and ask for the correct method of disposal.

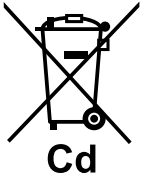

Note for the battery symbol (bottom two symbol examples):

This symbol might be used in combination with a chemical symbol. In this case it complies with the requirement set by the Directive for the chemical involved.

The following declaration is applicable to KX-UDT121CE/ KX-UDT121UK only

CE 0470

This device is a DECT Portable station operating in the frequency band of 1880 MHz to 1900 MHz.

The usage of this device is generally allowed in all EU countries.

Panasonic System Networks Co., Ltd. declares that this equipment is in compliance with the essential requirements and other relevant provisions of Radio & Telecommunications Terminal Equipment (R&TTE) Directive 1999/5/EC.

Declarations of Conformity for the relevant Panasonic products described in this manual are available for download by visiting:

<http://www.doc.panasonic.de>

Contact to Authorised Representative:
Panasonic Testing Centre
Panasonic Marketing Europe GmbH
Winsbergring 15, 22525 Hamburg, Germany

For users in New Zealand

- This equipment shall not be set to make automatic calls to the Telecom '111' Emergency Service.

PTC General Warning

- The grant of a Telepermit for any item of terminal equipment indicates only that Telecom has accepted that the item complies with minimum conditions for connection to its network. It indicates no endorsement of the product by Telecom, nor does it provide any sort of warranty. Above all, it provides no assurance that any item will work correctly in all respects with another item of Telepermitted equipment of a different make or model, nor does it imply that any product is compatible with all of Telecom's network services.

The Use of IP Networks through the PSTN

- Internet Protocol (IP) by its nature introduces delay into speech signals as each data packet is formulated and addressed. Telecom Access Standards recommends that suppliers, designers

and installers using this technology for calls to or from the PSTN refer to ITU E Model requirements in the design of their networks. The overall aim is to minimise delay, distortion and other transmission impairments, particularly for those calls involving cellular and international networks, which already suffer extensive delay.

Echo cancellation

- Echo cancellers are not normally required in the Telecom PSTN because geographic delays are acceptable where CPE return loss is maintained within Telepermit limits. However, those private networks making use of Voice over IP technology are required to provide echo cancellation for all voice calls. The combined effect of audio / VoIP conversion delay and IP routing delay can cause the echo cancellation time of ≥ 64 mS to be required.

PTC200 6.11.1 (3) All Customer Equipment (fail safe requirements)

- Under power failure conditions this appliance may not operate. Please ensure that a separate telephone, not dependent on local power, is available for emergency use.

For users in Singapore only

Complies with
IDA Standards
DB 01017

For Users in Hong Kong only



For Best Performance

Operating Range

- The range of operation depends on the topography of your office, weather, or usage conditions, because signals are transmitted between the CS and the handset by radio waves.
- Normally, you get greater range outdoors than indoors. If there are obstacles such as walls, noise may interfere with your telephone calls. In particular, high metal shelves or reinforced concrete walls will restrict your operating range.
- A handset may not work when it is too far from the CS depending on the structure of the building.
- We strongly suggest you hold the bottom half of the handset to ensure better call quality. Because, the antenna is located in the upper half of the handset.

Noise

Occasional noise or interference may occur due to electromagnetic radiation from objects such as refrigerators, microwave ovens, faxes, TVs, radios, or personal computers. If noise disturbs your telephone calls, keep the handset away from these electrical appliances.

Environment

- Keep the product away from heating appliances and devices that generate electrical noise, such as fluorescent lamps and motors. These noise sources can interfere with performance of the product.
- Do not place the product in rooms where the temperature is less than 0 °C or greater than 40 °C.
- To avoid damage, charge the battery only in temperatures ranging from 5 °C to 40 °C.
- Allow 10 cm clearance around the product for proper ventilation.
- Avoid environments with excessive smoke, dust, moisture, mechanical vibration, shock, or direct sunlight.
- The apparatus is designed to be installed and operated under controlled conditions of ambient temperature and a relative humidity.

Routine Care

- Unplug the charger from the AC outlet before cleaning.
- Wipe the product with a soft cloth.
- Do not clean the product with abrasive powder or with chemical agents such as benzine or thinner.
- Do not use liquid cleaners or aerosol cleaners.
- Clean the terminal of the charger periodically.

Placement

- Do not place heavy objects on top of the handset and charger.
- Care should be taken so that objects do not fall onto, and liquids are not spilled into, the product.
- Place the charger on a flat surface. If the charger is mounted on the wall, install it straight.

Bluetooth

- A Bluetooth headset can communicate with the handset within a range of approximately 10 m. The connection may be subject to interference from obstructions such as walls or electronic devices. For best performance, we recommend using a Bluetooth headset within 1 m of the handset.
- This unit complies with the Bluetooth wireless technology 2.0 specification.

Battery Information

After your Panasonic battery is fully charged (at 25 °C):

Operation	Operating Time
While Talking (Backlight off ¹ , Bluetooth off, Narrowband Mode)	Up to about 13 h
While Talking (Backlight on ² , Bluetooth on, Wideband Mode)	Up to about 7 h
While not in use (Standby)	Up to about 200 h

¹ When the "Talking" setting of "Backlight" is set to "Off". For details, see "Display Option (Page 50)".

² When the "Talking" setting of "Backlight" is set to "On". For details, see "Display Option (Page 50)".

- Operating time may be shorter than listed above depending on usage conditions and ambient temperature.
- The battery will drain slowly even while the handset is turned off.
- The handset can receive calls while charging.
- Battery consumption increases when the handset is out of range (if "T" flashes, turn the handset off).
- **Clean the handset and the charger contacts with a soft, dry cloth once a month. Clean more often if the unit is subject to grease, dust or high humidity.** Otherwise the battery may not charge properly.

Low Battery Warning

The battery needs to be charged in the following situations:

- The battery level indicator displays as empty ("🔋") and the alarm sounds¹.
- "Charge Battery" is displayed. In this situation, the handset cannot be operated.

¹ If the low battery warning occurs during a conversation, the handset will turn off in one minute.

Replacing the Battery

If the battery level indicator displays as empty ("🔋") after using the phone for a short time, even when the battery has been fully charged, the battery should be replaced. Before replacing the battery, make sure the low battery warning is displayed, then turn off the power to prevent memory loss. Replace the battery and charge the new battery for about 3 hours.

If you replace the battery before the low battery warning appears, the battery strength icon may display an incorrect reading. In this case, use the handset as normal with the new battery installed. To install the battery, see "Battery Installation (Page 54)".

When the low battery warning is displayed, charge the battery for about 3 hours. The battery strength icon will then display the correct reading.

- Please use only Panasonic batteries. For details, consult your administrator or dealer.
- There is a danger of explosion if the battery is incorrectly replaced.

Before Operating the Telephone

Accessory Information

Included Accessories

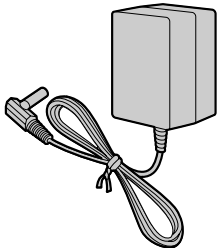
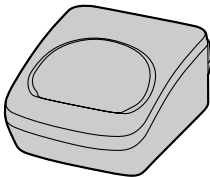
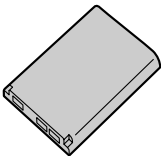
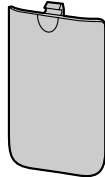
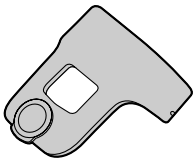
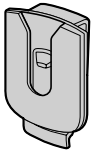
AC adaptor: 1										
	<table border="1"> <thead> <tr> <th>Model No.</th> <th>Part No.</th> </tr> </thead> <tbody> <tr> <td>KX-UJT121CE KX-UJT121RU</td> <td>PNLV226CE</td> </tr> <tr> <td>KX-UJT121UK</td> <td>PNLV226E</td> </tr> <tr> <td>KX-UJT121AL</td> <td>PNLV226AL</td> </tr> </tbody> </table>		Model No.	Part No.	KX-UJT121CE KX-UJT121RU	PNLV226CE	KX-UJT121UK	PNLV226E	KX-UJT121AL	PNLV226AL
	Model No.	Part No.								
	KX-UJT121CE KX-UJT121RU	PNLV226CE								
	KX-UJT121UK	PNLV226E								
KX-UJT121AL	PNLV226AL									
Charger: 1	Battery ¹ : 1	Battery Cover ² : 1								
										
Belt Clip: 1	Belt Clip Holder: 1									
										

¹ For details, consult your administrator or dealer.

² The battery cover comes attached to the handset.

Note

- The illustrations may differ from the appearance of the actual product.

Location of Controls

The headset is an optional accessory.

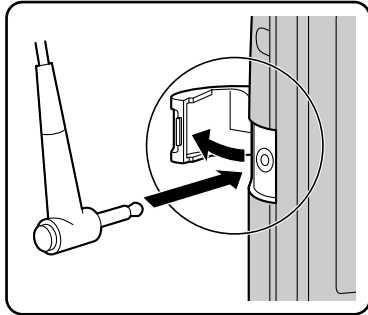

Open the cover.

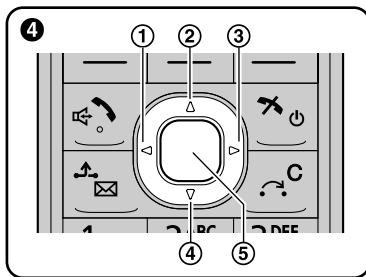

[Back View]

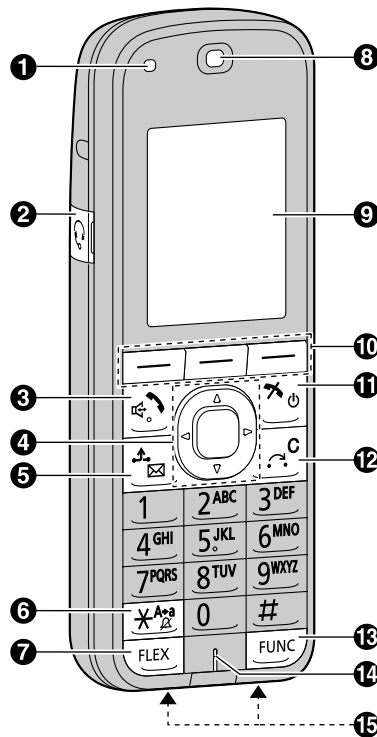
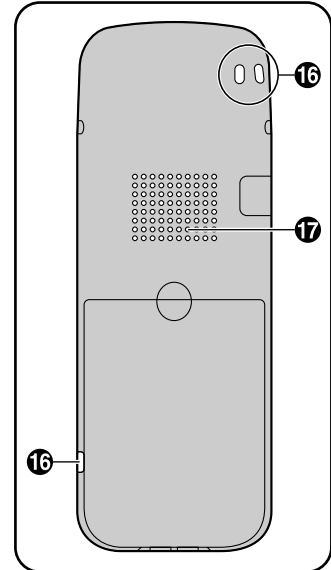

1 Ringer/Charge Indicator

2 Headset Jack

The following headsets can be used with this unit. (Not all operations with the headsets can be guaranteed.)

- Wired headsets
Panasonic RP-TCA400 and RP-TCA430
- Bluetooth headsets
Selected Plantronics®-brand headsets
Selected GN Netcom Jabra®-brand headsets

For up-to-date information about headsets that have been tested with this unit, refer to the following web site:

<http://panasonic.net/pcc/support/sipphone>

3 TALK/SP-PHONE (Speakerphone) Key

Used to make or answer calls, or toggle between Receiver mode and Hands-free mode during a conversation.

During a conversation using a headset, Hands-free mode does not work.

4 Navigator Key

The Navigator Key includes four arrow keys and a centre key. The arrow keys are used to adjust the ringer/receiver volume or move the cursor to select an item. The centre key is used to confirm a selection. If in standby mode, pressing the keys perform the following functions:

- ① LEFT (◀) → Used to display the Incoming call log.

- ② UP (▲) → Used to adjust the ringer volume.
- ③ RIGHT (▶) → Used to open the phonebook.
- ④ DOWN (▼) → Used to display the Outgoing call log.
- ⑤ CENTRE → Used to display the Menu.
In this manual, when a procedure instructs you to "press **OK**", you can also press the **[CENTRE]** key to confirm the selection.

⑤ HOLD/Voice Message Key

During talking, used to place a call on Hold. In standby mode, pressing this key plays your voice messages.

⑥ Silent Mode Key

Used to turn Silent Mode on or off when pressed for more than 2 seconds in standby mode. For details, see "Silent Mode (Page 17)".

⑦ Flexible Key

Pressing the **[FLEX]** key displays a menu with functions that have been assigned to each dial key (0–9, *, and #). The functions can be selected from the menu, or accessed quickly by pressing **[FLEX]**, then the assigned key.

⑧ Receiver

⑨ Display

For details, see "Display (Page 19)".

⑩ Soft Keys

The handset features 3 soft keys. By pressing a soft key, you can select the feature shown directly above it on the display. For details about the soft keys displayed here, see "Soft Keys (Page 20)".

⑪ POWER/CANCEL Key

Used to end calls, exit the phonebook or Function mode. Press and hold this key to turn the handset on or off.

⑫ TRANSFER/CLEAR Key

Used to transfer a call to another party, or to clear digits or characters.

⑬ Function Key

Pressing the **[FUNC]** key followed by a keypad number (0–9) allows you to perform various common functions quickly. For details, see "Function Keys (Page 24)".

⑭ Microphone

⑮ Charge Contacts

⑯ Strap Holes

Used to attach phone straps and similar items.

⑰ Speaker





Handset Functions

Setting the Password

The handset password is not set by default. You must register a handset password (4 digits) before use. You cannot use the following features without setting a password:

- Phonebook lock (See "Locking the Handset Phonebook (Page 38)".)
- "Manual&Password" or "Auto&Password" for Key Lock Type (See "Key Option (Page 49)".)
- Reset Handset (See "Other Option (Page 52)".)

To set

1. Press  or the [CENTRE] navigation key.
2. Select " Setting Handset" by pressing the arrow keys, and then press .
3. Press [▲] or [▼] to select "Other Option", and then press .
4. Press [▲] or [▼] to select "Change Password", and then press .
5. Enter a new password (4 digits [0–9]).
6. Verify the password by entering it again as in step 5.



Note

- To avoid unauthorised access to this product:
 - Set a password that is random and cannot be easily guessed.
 - Change the password regularly.
- Make a note of the password so that you will not forget it.



Key Lock

You can lock all keys other than the Navigator Key while the handset is in standby mode. One of 4 key lock types can be selected. For details, see "Key Option (Page 49)".

To lock

Press and hold  or the [CENTRE] navigation key for more than 2 seconds to lock the handset keys. The  icon will be displayed to indicate that the keys are locked.

To unlock

To unlock the handset keys, press and hold  or the [CENTRE] navigation key for more than 2 seconds. The  icon will change to  to indicate the keys have been unlocked.

Note

- If you select "Manual&Password" or "Auto&Password" for Key lock type, you need to enter the password to unlock the handset.
- If no password has been set, you cannot select "Manual&Password" or "Auto&Password" for Key lock type. To set the password, see "Setting the Password (Page 17)".

Silent Mode

Silent Mode turns off the ringer and sets the handset to vibrate when calls are received. This can be useful in situations where you do not want to be disturbed, such as during a meeting.

When Silent Mode is active, the following features are turned off or set as specified automatically, regardless of their settings.

- Ringer Volume
- Ring On Charger
- Auto Answer
- Key Tone
- Vibrate (Vib.& Ring)

To set or cancel

To set or cancel Silent Mode, press and hold  for more than 2 seconds.

Note

- If you set the handset on the charger during Silent Mode, the handset will not vibrate.¹
- When Silent Mode is set, the Low Battery Alarm will not be heard in standby mode.
- When Silent Mode is set, confirmation sounds for setting the ring pattern or ring volume will not play.

¹ Please note that if you set the handset on the charger while receiving an incoming call, vibration will stop. Once the vibration stops, the handset will not vibrate again for that call, even if the handset is lifted up again. (If Quick Answer is set, lifting up the handset will answer the call.)

Noise Reduction

When Noise Reduction is enabled, environmental noise is reduced to improve and maintain sound quality for the other party in the conversation. Receiver volume is also increased according to the level of environmental noise. It is useful in noisy environments such as warehouses, manufacturing plants, restaurants, and garages. Noise Reduction can be enabled by default for regular use, or toggled on/off during a call.

Enabling or disabling Noise Reduction

1. Press **FUNC**.
2. Press **[▲]** or **[▼]** to select "Noise Reduct.", and then press **OK**.
3. Press **[▲]** or **[▼]** to select "On" or "Off", and then press **OK**.

Temporarily enabling or disabling Noise Reduction during a call

You can enable or disable Noise Reduction during a call by doing either of the following:

- a. Press **FUNC**, then press **[▲]** or **[▼]** to select "Noise Reduct.", and then press **OK**.
or
- b. Press **[Mute]**. To display the **[Mute]** soft key, edit the displayed soft keys. See "Key Option (Page 49)".

Note

- Noise Reduction can be used only in Receiver mode or with a headset. It cannot be used in Hands-free mode. If Hands-free mode is enabled during a call while Noise Reduction is enabled, Noise Reduction will be temporarily disabled.

Power Save Mode

Power Save Mode turns off the ringer, LCD backlight, and/or key backlight automatically after a set number of seconds have passed while receiving a call. For details about adjusting power save mode settings, see "Incoming Option (Page 46)".

Display



1 Pictograph

	Within range of a Cell Station (CS)
	(Blinking) Out of range
	Off-hook Status
	Phonebook
	Voice Message
	Bluetooth on, no Bluetooth headset connection
	Bluetooth on, Bluetooth headset connected
	Incoming Call Log
	Outgoing Call Log
	Navigation Key Guidance

Battery Indicator^{*1}

		Full
		Low
		Needs to be charged

*1 For details, see "Battery Information (Page 12)".

2 Handset Status Information

	Vibration (See page 25)
	Ringer Off (See page 25)

	Silent Mode (See page 17)
	Auto Answer (See page 24)
	Microphone Mute
	Call Forwarding (See page 32)
	Do Not Disturb (See page 32)

3 Time Display

4 Date/Incoming Call Log Status/New Messages/Phonebook Error

	New Incoming Call Record
--	--------------------------

5 Handset's Phone Number and Name

To change the display of the handset's phone number, see "Changing the Handset Phone Number Display (Page 25)".

























6 Soft Keys











Note

- Example images of the display in this manual are samples only, and the actual screen on your phone may vary in colour and/or appearance.

Soft Keys

Icons and information shown on the display will vary depending on the context. To select an item shown on the display, press the corresponding soft key.

	Opens the phonebook. Pressing this key for more than 2 seconds locks the phonebook.		Used to save a setting.
	Displayed when in Phonebook Lock. Pressing this key and then entering the password (default: not registered), unlocks the phonebook temporarily. Pressing for more than 2 seconds, then entering the password (default: not registered), unlocks the phonebook. If no password has been set, you cannot lock the phonebook. For details about setting the password, see "Setting the Password (Page 17)".		Clears digits or characters.
	Stores a new item in the phonebook.		Turns the microphone mute feature on or off during a conversation. Flashes when Mic Mute is on.
	Make a call.		Turns the ringer off.
	Activate/deactivate Noise Reduction.		Opens the main menu. When in standby mode, pressing this key for than 2 seconds locks all keys.
	Used to set the Alarm.		Returns to the previous display.
	Reject an incoming call.		Opens the list menu (edit/delete in the phonebook, etc.).
	Establishes a multiple-party conversation (Conference).		Confirms the entry.
	Searches for an item in the phonebook alphabetically.		Displayed when in Key Lock mode. Pressing this key for more than 2 seconds unlocks the keys.
	Displayed when in Latin character entry mode. Pressing this key switches to Numeric character entry mode.		Advances to the next display.
	Displayed when in Numeric character entry mode. Pressing this key switches to Greek character entry mode.		Used to delete the setting.
	Displayed when in Greek character entry mode. Pressing this key switches to Special Character (Extended 1) character entry mode.		Displayed when in Special character (Extended 2) entry mode. Pressing this key switches to Latin character entry mode.

	Displayed when in Special character (Extended 1) entry mode. Pressing this key switches to Special character (Extended 2) character entry mode.		Used to select an item when in setting mode.
	Used to set Call Forwarding and Do Not Disturb.		Disconnects the current call and allows you to make another call without hanging up.
	Displays the Outgoing Call Log.		Used to select AM or PM when setting the Memo Alarm feature.
	Displays the last dialed number.		Perform an unscreened (blind) transfer.
	Opens the Incoming Call Log.		Used to set/clear Auto Answer mode when in standby mode. During a conversation, turns the microphone mute feature on or off. For details about the Mute/Auto Answer function, see "Function Keys (Page 24)".

Note

- The display of the soft keys can be customised. The soft keys displayed in standby mode or during a call can be set. The names of the soft keys can also be edited. For details, see "Key Option (Page 49)".

Other Icons

Icon	Description
	Displayed next to an extension from which a voice mail message is waiting. For details, see "Listening to Voice Mail Messages (Page 32)".

Flexible Keys

A Flexible Key can be used either to seize a line in order to make or receive a call, or used as a function key.

Press **FLEX** to display the Flexible Key list. Here you can access the 12 Flexible Keys. The colour of each key number indicates the status of the line or the status of the function assigned to the key.

[Example]

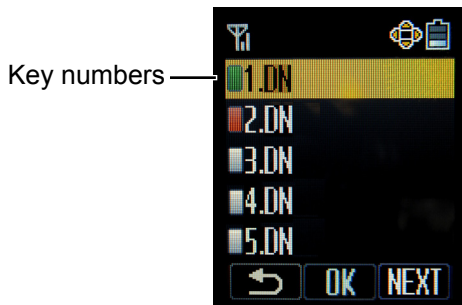

- To select a key, press **[▲]** or **[▼]** to select the desired key, and then press **OK**.
- To edit the names of Flexible Keys, see page 25.

The following types of flexible keys are available:

DN (Directory Number)

Seizes the line assigned to the DN key. When a call arrives at the DN key, pressing the key answers the call.

Status Indication

- **Off:** Idle
- **Green on:** You are on a call using the DN key.
- **Flashing green rapidly:** A call is being received.
- **Flashing green slowly:** A call is on hold.
- **Red on:** A shared line is in use or on private hold at another unit.
- **Flashing red slowly:** A shared line is on hold at another unit.

Note

- A shared line is a line that can be used by multiple units. This is an optional feature and may not be supported on your phone system.
- If a call is on private hold (red, steady on), the call cannot be retrieved except from the unit that put the call on hold.

Basic Operations

Operation Outline

Handset functions are accessed through the display menu and selected with the Navigator Key and soft keys.

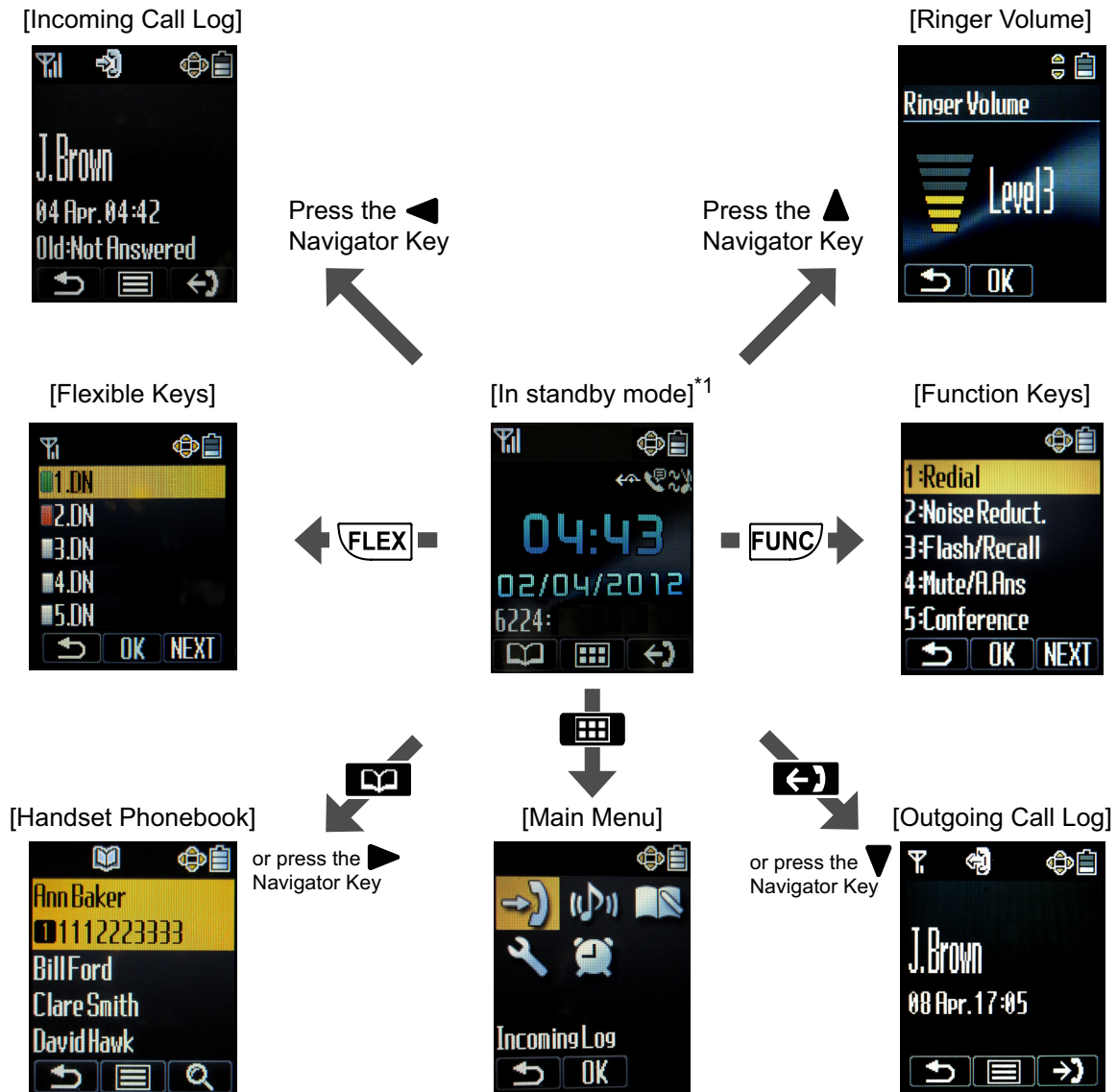

*1 If soft key display settings are changed, the soft keys shown here may not be displayed.





- The selected item will be highlighted.
- For details about entering characters, see "Entering Characters (Page 42)". For details about searching for an item in the phonebook, see "Searching for an Item in the Phonebook (Page 28)".

Function Menus

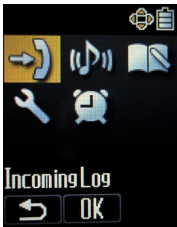
Press  or the [CENTRE] navigation key to display the main and sub menus.





Main Menu—While in Standby Mode



-  **Incoming Log**
Enters the Incoming Call Log.
-  **Ringer Volume**
Accesses the "Ringer Volume" setting.
-  **New Phonebook**
Stores a new item in the phonebook.
-  **Setting Handset**
Accesses the "Setting Handset" settings.
-  **Memo Alarm**
Accesses the "Memo Alarm" settings.





Sub Menu—While Off-hook/During a Conversation



-  **Phonebook**
Opens the phonebook.
-  **New Phonebook**
Stores a new item in the phonebook.
-  **Outgoing Log**
Enters the Outgoing Call Log.
-  **Incoming Log**
Enters the Incoming Call Log.
-  **Mute**
Turns the microphone mute feature on or off during a conversation.

Function Keys

Handset functions can be activated through the display key list.

1. Press  to display the function key list.
2. Press  or  to select the desired function, and then press .

You can also press the number key corresponding to a function number to select it directly.

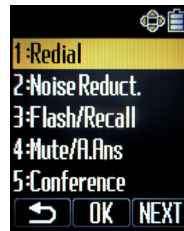

1: Redial

Call the last number that was dialled.

2: Noise Reduct.

Sets Noise Reduction.

3: Flash/Recall

Disconnects the current call and allows you to make another call without hanging up.

4: Mute/A.Ans

Automatically answers incoming calls in hands-free mode. "☎" is displayed in standby mode.

5: Conference

Establishes a multiple-party conversation.

6: Fwd/DND

Displays and/or sets Call Forwarding and Do Not Disturb.

7: Incoming Log

Makes a call using the Incoming Call Log.

8: Outgoing Log

List numbers that were recently dialled.

9: Phonebook

Makes a call using the phonebook.





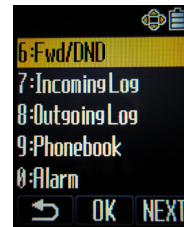

0: Alarm

Sets a memo alarm.



Selecting the Display Language







You can select the language displayed on your handset.

1. Press  or the [CENTRE] navigation key.
2. Select " Setting Handset" by pressing the arrow keys, and then press .
3. Press [▲] or [▼] to select "Display Option", and then press .
4. Press [▲] or [▼] to select "Language", and then press .
5. Press [▲] or [▼] to select a language¹, and then press .

¹ For a list of the languages that can be selected, see "Display Option (Page 50)".

Changing the Handset Phone Number Display

You can change the display of the handset's phone number when the handset is in standby mode.

1. Press  or the [CENTRE] navigation key.
2. Select " Setting Handset" by pressing the arrow keys, and then press .
3. Press [▲] or [▼] to select "Display Option", and then press .
4. Press [▲] or [▼] to select "Standby Display", and then press .
5. Press [▲] or [▼] to select the desired item, and then press .

Note

- By default, "Handset Number" is selected.
- For details about standby display settings, see "Display Option (Page 50)".





Editing the Names of the Flexible Keys

Web user interface programming is required to change the names of the Flexible Keys used for the handset. For details, consult your administrator or dealer.

Adjusting the Ringer Volume

The volume of the ringer can be adjusted, or turned off.

Adjusting the Ringer Volume or Turning the Ringer Off

1. Press  or the [CENTRE] navigation key.
2. Select " Ringer Volume" by pressing the arrow keys, and then press .
3. Press [▲] or [▼] to select the desired setting (Step Up, Step Down, Level 1–6, Off), and then press .

Note

- You can press the [▲] key instead of performing steps 1 and 2.
- For details about setting the ringer pattern, see "Incoming Option (Page 46)".

Adjusting the Ringer Volume or Turning the Ringer Off while Ringing

While receiving a call, do the following to adjust the ringer volume or turn the ringer off:

To adjust the ringer volume

Press [▲] or [▼] to adjust the volume¹.

To turn the ringer off





Press  or .

¹ The adjusted volume level will also be used for subsequent calls.

Note

- If you attach a headset while receiving an incoming call, the ring from the handset does not switch to the headset. If you attach a headset before receiving an incoming call, and headset ringer is set to "on", ringing will be heard from the headset.

Changing the Vibrate Setting

1. Press  or the [CENTRE] navigation key.
2. Select " Setting Handset" by pressing the arrow keys, and then press .
3. Press [▲] or [▼] to select "Incoming Option", and then press .
4. Press [▲] or [▼] to select "vibrate", and then press .

5. Press [**▲**] or [**▼**] to select the desired setting (Vib. & Ring, Vib. → Ring, Off), and then press **OK**.

Note

- To set Vibrate only, without ringing, select "Vib. & Ring" and set the Ringer Volume to "Off", or turn Silent Mode on. For details, see "Location of Controls (Page 15)" and "Adjusting the Ringer Volume (Page 25)".

Adjusting the Receiver/ Speaker/Headset Volume

During a conversation, press [**▲**] or [**▼**] to adjust the volume (Level 1–6).

Note



- If you are using a Bluetooth headset, you can also adjust the receiver volume by using the volume key on the Bluetooth headset. For details about using a Bluetooth headset, see "Bluetooth (Page 32)".

Feature Operations

Making Calls

Calling

Calling by Dialling

1. Press .
2. Dial the outside party's number.
3. Press **CALL**.
4. To end the call, press .

Predialling



In standby mode, you can start dialling while still on-hook. After dialling the number, press  to go off-hook and begin the call.

Note



- Alternatively, you can seize a specific line for making the call by pressing **FLEX** and selecting an idle DN key.
- To cancel dialling, press .
- If "Y" flashes, move closer to the CS and dial again.
- If you are using a Bluetooth headset, see "Call Handling with a Bluetooth Headset (Page 34)".

Using the Outgoing Call Log



If a call is received from a phone number stored in the phonebook, the number and name of the caller will be displayed in the call log.

1. While in standby mode, press [**▼**] or .
2. Press [**▲**] or [**▼**] to select an outgoing call record, and then press .
3. To end the call, press .

Using the Incoming Call Log

1. While in standby mode, press [**◀**].
2. Press [**▲**] or [**▼**] to select an incoming call record, and then press .
3. To end the call, press .

Using the Phonebook

1. Press [**▶**] or .
2. Select an item stored in the phonebook, and then press .
3. To end the call, press .

Note

- For details about searching for an item in the phonebook, see "Searching for an Item in the Phonebook (Page 28)".
- For details about entering characters, see "Entering Characters (Page 42)".
- For details about storing an item in the phonebook, see "Storing an Item in the Handset Phonebook (Page 36)".

One-touch Dialling

You can make a call with a One-touch operation if a One-touch Dialling key has been created for the desired party. One-touch Dialling keys can also be configured to access features of your phone system, if available.

1. Press **FLEX**, and then press the One-touch Dialling key (flexible key).
2. To end the call, press .

Note

- For details about Flexible Keys, see "Flexible Keys (Page 22)".

Hot Key Dialling

You can assign a phone number to each number key and then access the desired phone number by simply pressing and holding the assigned number key.

1. Press and hold the dialling key (0–9) assigned as a Hot Key for more than 1 second.
2. Press .



Note

- While the Hot Key's information is displayed, you can press [**▲**] or [**▼**] to select another Hot Key number.
- If Hot Key dialling is set to "Auto", a Hot Key number can also be dialled by pressing and holding the assigned dialling key for a specified number of seconds. For details, see "Selecting the Type of Hot Key Dialling (Page 40)".

- For details about assigning Hot Keys, see "Assigning Hot Keys (Page 40)".



Searching for an Item in the Phonebook

You can search for an item in the phonebook, and then make a call.

1. While in standby mode, press [▶] or .
2. Press [▲] or [▼] to select the desired item.
3. Press .



Searching by Name

You can also search for an item in the phonebook by entering a name:

1. While in standby mode, press [▶] or .
2. Press .
3. Enter the name or the first character(s) of the desired name, and then press **OK**.
4. Press [▲] or [▼] to select the desired item.
5. Press .

Searching by Category

If items in the phonebook have been assigned categories, you can search by category.

1. While in standby mode, press [▶] or .
2. Press , and then press #.
3. Press [▲] or [▼] to select a category, and then press **OK**.
4. Enter the name or the first character(s) of the desired name of the item in the category, and then press **OK**.
5. Press [▲] or [▼] to select the desired item.
6. Press .

Note

- If one item has multiple phone numbers stored, you can press the [CENTRE] navigation key, and then press [▲] or [▼] to select the desired phone number for that item.
- Characters that are entered using the # key (for example, "\$") cannot be entered when searching the phonebook.
- For details about entering characters, see "Entering Characters (Page 42)".

- While an item is displayed you can press  to return to the "<Enter Name>" display, and then search for another item.

Receiving Calls

Receiving

To answer an incoming call, press .

Note

- If you are using a Bluetooth headset, see "Call Handling with a Bluetooth Headset (Page 34)".

To answer an incoming call on a specific line

- Press **FLEX** to display the flexible keys.
- Press the flexible key number, or press **[▲]** or **[▼]** to select the desired key, and then press **OK**.

You can also answer a call using the following features:

- Any Key Answer
- Quick Answer
- Auto Ans Delay

For details about setting these features, see "Answer Option (Page 48)".

Note

- If an incoming call is directed to PS ring groups¹, the flexible keys will not flash. Please press TALK button to answer the call.
- Flexible keys with incoming calls will be flashing green rapidly.
- If "Quick Answer" is set to "On" and a brief power failure occurs while the handset is receiving a call on the charger, the following may occur:
 - If "Talk On Charger" is set to "Off" (default), the call may be disconnected after being answered.
 - If "Talk On Charger" is set to "On", the call may be answered automatically. In this case, please note that privacy rights may be violated or sensitive information may be transmitted to unauthorised parties.
- You can select the ringer pattern and LED pattern for each type of incoming call. For details, see "Incoming Option (Page 46)".

¹ The PS ring group is available if the CS is connected to a KX-NS1000 PBX. For details, refer to the documentation of the KX-NS1000.

Rejecting an incoming call

You can reject an incoming call from your handset.

- While an incoming call is ringing, press .
- The call will be rejected, and the handset will return to standby mode.

Rejecting calls from specific numbers

Calls from specific numbers can be automatically rejected. This feature can be enabled through Web user interface programming. For details, contact your administrator or dealer.

Note

- The rejecting call is not available if the CS is connected to a KX-NS1000 PBX.

Caller ID

If an outside call that contains Caller ID information (a caller's name and telephone number) is received, this information will be logged in the incoming call log and displayed on the handset.

If a call from a number matching a number entered in the phonebook is received, the name registered in the phonebook for that number will be displayed along with the number.

[Example]

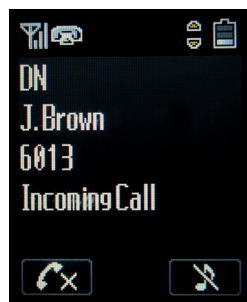

If caller information is sent by the phone system and there is also information stored in the phonebook for the same number, you can choose which information will be displayed on the handset. Caller information sent by the phone system is displayed by default. For details, see "Display Option (Page 50)".

If you set the handset to display the caller information stored in the phonebook, caller information sent by the phone system will only be displayed if the number of the caller is not stored in the phonebook.

Note



- The soft key to reject an incoming call is not displayed on the handset if the CS is connected to a KX-NS1000 PBX.

During a Conversation

Holding a Call

You can put a call on hold by holding the call at your extension.

To hold the current call

Press , and then press .

Note

- If Automatic Call Hold is enabled on your handset, the call will also be put on hold if you select a DN key other than the one for the current call. For details, consult your administrator or dealer.



To retrieve a call on hold at your extension

1. Press **FLEX**.
2. Press the dial key corresponding to the slowly flashing green DN key, or press [**▲**] or [**▼**] to select a slowly flashing green DN key, and then press **OK**.

Transferring a Call (Call Transfer)

You can transfer a call to another destination (extension or outside party).

To transfer

1. Press  during a conversation.
2. Dial the party you want to transfer to, and then press **CALL**.
3. Wait until the other party answers to announce the transfer.
4. Press .

Note

- To return to the call before the transfer destination answers, press .
- If unscreened transfers are supported on your phone system, step 3 can be omitted. For details, consult your administrator or dealer.

To do a blind transfer¹

1. Press **BLIND** during a conversation.

2. Dial the party you want to transfer to, and then press **CALL**.

¹ A blind transfer is not available if the CS is connected to a KX-NS1000 PBX.

Three-party Conference

During a conversation, you can add an additional party to your call and establish a conference call.

Notice

- If the CS is connected to a KX-NS1000 PBX, refer to the documentation for the PBX.
- Your phone system may support advanced conference features, such as conference calls with four or more parties. In this case, the procedures for handling a conference call may be different from those explained in this section. For details about your phone system, consult your administrator or dealer.

Making a Conference Call



1. Press **FUNC**, and then press 5 ("Conference").
2. Dial the party you want to add to the conversation, and then press **CALL**.
3. After the called party answers, press **FUNC**, and then press 5 ("Conference").

Note

- The  soft key can also be used to access the Conference function directly. To display this key, edit the displayed soft keys. For details, see "Key Option (Page 49)".

Removing a Party from the Conference

During a conference, you can remove other parties from the conference. However, this operation is available only during conference calls you initiate.

1. During a conference call, press .
2. Press **FLEX**.
3. Press the dial key, or press [**▲**] or [**▼**], and then press **OK** to select the DN key (flexible key) that corresponds to the party you want to disconnect.
4. Press .
5. Press **FLEX**.
6. Press the dial key, or press [**▲**] or [**▼**], and then press **OK** to select the DN key (flexible key) that corresponds to the remaining party.

Note

- To reestablish the conference without removing either party, press **FUNC**, and then 5 ("Conference") after step 3.

Ending a Conference Call

To go on-hook and end the conference call, press



Useful Features

Call Forwarding/Do Not Disturb

You can have incoming calls automatically forwarded to another destination. You can also have incoming calls rejected (Do Not Disturb).

To access the FWD/DND settings

1. In standby mode, press **FUNC**, and then 6 ("Fwd/DND").
2. If the unit has multiple lines, press **[▲]** or **[▼]** to select the desired line, and then press **OK**.
3. Press **[▲]** or **[▼]** to select the type of FWD or DND setting to apply, and then press **OK**.



The settings are as follows:

- **Fwd/DND Off¹**: Disable Forward and Do Not Disturb (All incoming calls are accepted.)
- **DND**: Enable Do Not Disturb (All incoming calls are automatically rejected.)
- **Fwd (All)**: Enable Forward All Calls (All incoming calls are forwarded.)
- **Fwd (Busy)**: Enable Forward Busy (Incoming calls are forwarded only when your extension is in use.)
- **Fwd (NA)**: Enable Forward No answer (An incoming call is forwarded if you do not answer the call within a certain amount of time.)
- **Fwd (B/NA)¹**: Enable Forward Busy or No Answer (An incoming call is forwarded when your extension is in use or you do not answer the call within a certain amount of time.)

¹ Fwd/DND Off and Fwd(B/NA) are only available if the CS is connected to a KX-NS1000 PBX.

4. If a Forward setting is selected, enter a new forward destination number, or confirm and modify a previously set forward destination number.
 - If the CS is connected to a KX-NS1000 PBX, press **#** and then press **OK**.
 - If the CS is not connected to a KX-NS1000 PBX, press **OK**.



Note

- When Call Forwarding and/or Do Not Disturb is enabled,  and/or  appears on the display in standby mode.
- FWD settings cannot be used on a shared line.

Call Waiting

During a conversation, if a second call arrives, you will hear a call waiting tone. You can answer the second call by disconnecting or holding the current call.

To disconnect the current call and then talk to the new party

1. Press  while hearing the call waiting tone.
2. Press .



To hold the current call and then talk to the new party

1. Press  while hearing the call waiting tone.
2. Press **FLEX**.
3. Press the dial key corresponding to the flashing green DN key, or press **[▲]** or **[▼]** to select a flashing green DN key, and then press **OK**.

Listening to Voice Mail Messages

When you receive a voice message, "Message" is displayed, and  will appear.

You can check your new messages by accessing your mailbox.

1. In standby mode, press and hold .
2. Press **[▲]** or **[▼]** to select the line on which  is displayed, and then press **OK**.

Note

- Step 2 is not necessary if only one line is configured on the handset.

Bluetooth

You can use Bluetooth to connect to a Bluetooth wireless headset and transfer phonebook data from a cell phone.

Turning Bluetooth On or Off



Before using Bluetooth to connect to a wireless Bluetooth headset or to a cell phone, Bluetooth must be set to "On" in the handset settings.

1. Press  or the **[CENTRE]** navigation key.

2. Select " Setting Handset" by pressing the arrow keys, and then press **OK**.
3. Press [**▲**] or [**▼**] to select "Bluetooth Option", and then press **OK**.
4. Press [**▲**] or [**▼**] to select "On/Off", and then press **OK**.
5. Press [**▲**] or [**▼**] to select "On" or "Off", and then press **OK**.

Setting and Changing the Bluetooth PIN Number

Before using Bluetooth to connect to a cell phone, you must set the Bluetooth PIN number in the handset settings.

1. Press  or the [CENTRE] navigation key.
2. Select " Setting Handset" by pressing the arrow keys, and then press **OK**.
3. Press [**▲**] or [**▼**] to select "Bluetooth Option", and then press **OK**.
4. Press [**▲**] or [**▼**] to select "Cell Phone", and then press **OK**.
5. Press [**▲**] or [**▼**] to select "Change BT PIN", and then press **OK**.
6. Enter the old PIN number.¹
7. Enter a PIN number (4 digits), and then press **OK**.
8. Re-enter the same PIN number as in step 7, and then press **OK**.

¹ If a PIN number has not been set previously, skip this step and continue to step 7.

Note

- The valid digits are 0–9.

Registering and Deregistering the Bluetooth Headset



You can use a wireless Bluetooth headset with a handset. Before using a Bluetooth headset, you must register it to a handset.

Registering a Bluetooth Headset

Notice

- Perform any procedures on the headset necessary for registering it before configuring the settings on the handset. Otherwise, the Bluetooth headset may not be registered.



To register a Bluetooth headset when none is registered

1. Press  or the [CENTRE] navigation key.
2. Select " Setting Handset" by pressing the arrow keys, and then press **OK**.
3. Press [**▲**] or [**▼**] to select "Bluetooth Option", and then press **OK**.
4. Press [**▲**] or [**▼**] to select "BT Headset", and then press **OK**.
5. Enter the headset's Bluetooth PIN number, and then press **OK**.

Note

- Up to 4 digits can be entered for the Bluetooth headset's PIN number.



To register a Bluetooth headset when one is already registered

1. Press  or the [CENTRE] navigation key.
2. Select " Setting Handset" by pressing the arrow keys, and then press **OK**.
3. Press [**▲**] or [**▼**] to select "Bluetooth Option", and then press **OK**.
4. Press [**▲**] or [**▼**] to select "BT Headset", and then press **OK**.
5. Press [**▲**] or [**▼**] to select "Registration", and then press **OK**.
6. Press [**▲**] or [**▼**] to select "Register", and then press **OK**.
7. Enter the headset's Bluetooth PIN number, and then press **OK**.

Note

- Only one Bluetooth headset can be registered to the handset. Registering a new Bluetooth headset overwrites the current registration.
- Up to 4 digits can be entered for the Bluetooth headset's PIN number.



Deregistering the Bluetooth Headset

1. Press  or the [CENTRE] navigation key.
2. Select " Setting Handset" by pressing the arrow keys, and then press **OK**.
3. Press [▲] or [▼] to select "Bluetooth Option", and then press **OK**.
4. Press [▲] or [▼] to select "BT Headset", and then press **OK**.
5. Press [▲] or [▼] to select "Registration", and then press **OK**.
6. Press [▲] or [▼] to select "Deregister", and then press **OK**.
7. Press [▲] or [▼] to select "Yes", and then press **OK**.

Connecting and Disconnecting a Bluetooth Headset

You can connect a registered Bluetooth headset with a handset.



Connecting a Bluetooth Headset

1. Press  or the [CENTRE] navigation key.
2. Select " Setting Handset" by pressing the arrow keys, and then press **OK**.
3. Press [▲] or [▼] to select "Bluetooth Option", and then press **OK**.
4. Press [▲] or [▼] to select "BT Headset", and then press **OK**.
5. Press [▲] or [▼] to select "Connection", and then press **OK**.
6. Press [▲] or [▼] to select "On", and then press **OK**.

Note

- The default setting is "On".

Disconnecting the Bluetooth Headset

1. Press  or the [CENTRE] navigation key.
2. Select " Setting Handset" by pressing the arrow keys, and then press **OK**.

3. Press [▲] or [▼] to select "Bluetooth Option", and then press **OK**.
4. Press [▲] or [▼] to select "BT Headset", and then press **OK**.
5. Press [▲] or [▼] to select "Connection", and then press **OK**.
6. Press [▲] or [▼] to select "Off", and then press **OK**.



Call Handling with a Bluetooth Headset

You can make or answer a call using the Bluetooth headset.



Note

- In this manual, the names of buttons and features described for Bluetooth headsets are examples only. Your Bluetooth headset's button names or features may differ. Consult the documentation for your Bluetooth headset for operation and feature information.

Making a Call with the Bluetooth Headset

1. Dial the outside party's number.
2. Press  on the handset or the [TALK] button on the Bluetooth headset.
3. To end a call, press  on the handset or the [TALK] button on the Bluetooth headset.

Answering a Call Using a Bluetooth Headset

1. Press  on the handset or the [TALK] button on the Bluetooth headset.
2. To end a call, press  on the handset or the [TALK] button on the Bluetooth headset.

Note

- When a call is received, if the headset ringer is on, the Bluetooth headset will ring even if the handset is set to Silent Mode, or if "Vibrate" or "Ring On Charger" is enabled.

Switching a Conversation between the Handset and a Bluetooth Headset



To switch a conversation from the handset to the Bluetooth headset

- Press  twice.

To switch a conversation from the Bluetooth headset to the handset

- Press .

Adjusting the Microphone Volume of a Bluetooth Headset

1. Press  or the [CENTRE] navigation key.
2. Select " Setting Handset" by pressing the arrow keys, and then press **OK**.
3. Press [▲] or [▼] to select "Bluetooth Option", and then press **OK**.
4. Press [▲] or [▼] to select "BT Headset", and then press **OK**.
5. Press [▲] or [▼] to select "Headset Mic Vol", and then press **OK**.
6. Press [▲] or [▼] to adjust the volume (Level 1–6), and then press **OK**.

Note

- The microphone volume for the Bluetooth headset can only be adjusted when the handset is in standby mode.

Registering and Deregistering a Cell Phone for Phonebook Transfer

You can transfer the phonebook data of a cell phone to the handset. Before performing the transfer, you must register the cell phone to the handset. For details about transferring a phonebook, see "Phonebook and vCard Transfer by Bluetooth (Page 38)".

Registering a Cell Phone



1. Press  or the [CENTRE] navigation key.

2. Select " Setting Handset" by pressing the arrow keys, and then press **OK**.
3. Press [▲] or [▼] to select "Bluetooth Option", and then press **OK**.
4. Press [▲] or [▼] to select "Cell Phone", and then press **OK**.
5. Press [▲] or [▼] to select "Registration", and then press **OK**.
6. If the "Register/Deregister" menu is displayed, press [▲] or [▼] to select "Register", and then press **OK**. Otherwise, proceed to step 7.
7. Complete the registration by operating the cell phone.

Note

- Follow the procedure above before doing any operations on the cell phone. Otherwise, the cell phone may not be registered.
- When you operate the cell phone, the handset's Bluetooth PIN number is required. For details, see "Setting and Changing the Bluetooth PIN Number (Page 33)".

Deregistering a Cell Phone

1. Press  or the [CENTRE] navigation key.
2. Select " Setting Handset" by pressing the arrow keys, and then press **OK**.
3. Press [▲] or [▼] to select "Bluetooth Option", and then press **OK**.
4. Press [▲] or [▼] to select "Cell Phone", and then press **OK**.
5. Press [▲] or [▼] to select "Registration", and then press **OK**.
6. Press [▲] or [▼] to select "Deregister", and then press **OK**.
7. Press [▲] or [▼] to select "Yes", and then press **OK**.

Customising the Telephone

Using the Handset Phonebook

You can store up to 500 phone numbers in the handset along with names for easy access. You can also set unique ringer patterns and LED patterns for different categories to identify incoming calls. All phonebook items are stored in alphabetical order. For security purposes, you can lock the phonebook. For details about making calls from the phonebook, see "Using the Phonebook (Page 27)".

Note

- A single entry (i.e., name) can have multiple phone numbers. Since the phonebook capacity is limited by the number of stored phone numbers, storing multiple phone numbers in an entry decreases the maximum number of entries.
- We recommend that backups are made of the handset's phonebook data, in case the data becomes unrecoverable due to product malfunction. For details, consult your administrator or dealer.

Private Ring











You can organise entries in the phonebook into one of 9 Private Ring Categories. It is possible to set a different ringer pattern and LED pattern, vibration pattern, and colour pattern¹ for each category. When the displayed Caller ID² matches a phone number or name stored in the phonebook, the handset rings according to the Private Ring Category settings.

¹ For details about ringer patterns, LED patterns, vibration patterns, and colour patterns, see "Incoming Option (Page 46)".

² For details about Caller ID information, see "Caller ID (Page 29)".

Storing an Item in the Handset Phonebook

Storing a New Item



1. Press  or the [CENTRE] navigation key.
2. Select " New Phonebook" by pressing the arrow keys, and then press .
3. Enter a name (max. 24 characters), and then press .
4. Press [▲] or [▼] to select a phone number type (① to ⑤), and then press .
5. Enter the phone number (max. 32 digits), and then press .
6. Repeat steps 4 and 5 to add additional phone number types.
7. Press [▲] or [▼] to select "Category Off", and then press .
8. Select a category, and then press .
9. To select a default number for the entry, press [▲] or [▼] to select "Default TEL No", and then press .
10. Press [▲] or [▼] to select the number to use as the default number, and then press .
11. Press .

Note

- Steps 7 and 8 can be omitted if you do not want to assign a category.
- Steps 9 and 10 can be omitted if you do not want to assign a default number. (The first number entered for an entry will automatically be assigned as the default number.)
- The valid digits are "0" through "9", "×", "#", and "+".
- For details about entering characters, see "Entering Characters (Page 42)".
- If an item with the same name and number exists, the new information added will be merged with the existing item.



Editing a Stored Item

You can edit the information stored in phonebook entries.

1. Press .
2. Press [▲] or [▼] to display the desired entry, or press  and search for the desired entry.

3. Press  to open the phonebook sub-menu.
4. Press [**▲**] or [**▼**] to select "Edit", and then press **OK**.
5. Edit the name, phone number, category, and default number setting as necessary.
6. Press **SAVE**.

Note

- To change a character or digit, press [**◀**] or [**▶**] to highlight it, press  to delete it, and then enter the new character or digit.
- To clear an entire line, press and hold  for more than 1 second.
- To move the cursor to the left or right, press [**◀**] or [**▶**], respectively.
- For details about searching for an item in the phonebook, see "Searching for an Item in the Phonebook (Page 28)".
- For details about entering characters, see "Entering Characters (Page 42)".

Storing an Item Using Predialling

You can dial a number first and then add it as a phonebook entry.

1. In standby mode, dial a number.
2. Press .
3. Enter a name (max. 24 characters), and then press **OK**.
4. Press [**▲**] or [**▼**] to select a phone number type (① to ⑤), and then press **OK**.
5. Enter the phone number (max. 32 digits), and then press **OK**.
6. Repeat steps 4 and 5 to add additional phone number types.
7. Press [**▲**] or [**▼**] to select "Category Off", and then press **OK**.
8. Select a category, and then press **OK**.
9. To select a default number for the entry, press [**▲**] or [**▼**] to select "Default TEL No", and then press **OK**.
10. Press [**▲**] or [**▼**] to select the number to use as the default number, and then press **OK**.
11. Press **SAVE**.

Note

- Steps 7 and 8 can be omitted if you do not want to assign a category.

- Steps 9 and 10 can be omitted if you do not want to assign a default number. (The first number entered for an entry will automatically be assigned as the default number.)
- For details about entering characters, see "Entering Characters (Page 42)".

Storing an Item Using the Incoming or Outgoing Call Log

You can add a number listed in the incoming or outgoing call log to the phonebook.







1. In standby mode, press [**◀**] to open the Incoming Call Log or press [**▼**] to open the Outgoing Call Log.
2. Press [**▲**] or [**▼**] to select a record in the log.
3. Press  to open the phonebook sub-menu.
4. Press [**▲**] or [**▼**] to select "Save Phonebook", and then press **OK**.
5. Edit the name if desired, and then press **OK**.
6. Press [**▲**] or [**▼**] to select a phone number type (① to ⑤), and then press **OK**.
7. Edit the phone number if desired, and then press **OK**.
8. Repeat steps 6 and 7 to add additional phone number types.
9. Press [**▲**] or [**▼**] to select "Category Off", and then press **OK**.
10. Select a category, and then press **OK**.
11. To select a default number for the entry, press [**▲**] or [**▼**] to select "Default TEL No", and then press **OK**.
12. Press [**▲**] or [**▼**] to select the number to use as the default number, and then press **OK**.
13. Press **SAVE**.

Note

- Steps 9 and 10 can be omitted if you do not want to assign a category.
- Steps 11 and 12 can be omitted if you do not want to assign a default number. (The first number entered for an entry will automatically be assigned as the default number.)
- For details about entering characters, see "Entering Characters (Page 42)".

Editing Category Names

You can edit the names of the categories in the phonebook.

1. Press  or the [CENTRE] navigation key.
2. Select " Setting Handset" by pressing the arrow keys, and then press .
3. Press [▲] or [▼] to select "Display Option", and then press .
4. Press [▲] or [▼] to select "Category Name", and then press .
5. Press [▲] or [▼] to select the desired category number (1–9), and then press .
6. Enter a name for the category (max. 13 characters), and then press .
7. Repeat steps 5 and 6 for each category name to edit.

Note



- For details about entering characters, see "Entering Characters (Page 42)".

Locking the Handset Phonebook



You can lock/unlock the phonebook while the handset is in standby mode. If no password has been set, you cannot lock the phonebook. For details about setting the password, see "Setting the Password (Page 17)".

Locking/Unlocking the Phonebook

To lock

- Press and hold  for more than 2 seconds.  will be displayed.

To unlock

1. Press and hold  for more than 2 seconds.
2. Enter your password.
3. Press  to return to standby mode.

Unlocking the Phonebook Temporarily

1. Press .
2. Enter your password.

Phonebook and vCard Transfer by Bluetooth









Transferring Phonebook Data from a Cell Phone using Bluetooth

You can transfer the phonebook data of a cell phone to the handset using Bluetooth wireless transmission. For details about Bluetooth, see "Bluetooth (Page 32)".







Notice

- The cell phone must support PBAP (Phone Book Access Profile) to use this function.

To transfer the phonebook data of a registered cell phone to the handset

1. Press  or the [CENTRE] navigation key.
2. Select " Setting Handset" by pressing the arrow keys, and then press .
3. Press [▲] or [▼] to select "Bluetooth Option", and then press .
4. Press [▲] or [▼] to select "Cell Phone", and then press .
5. Press [▲] or [▼] to select "Phonebook", and then press .
6. Press .
7. Press [▲] or [▼] to select "1: (your cell phone name)", and then press .
8. Press [▲] or [▼] to select "Auto" or "Manual", and then press .
 - If you select "Auto", the download will started automatically.
 - If you select "Manual", operate the transfer from the cell phone to start the download.

To transfer the phonebook data of an unregistered cell phone to the handset

1. Press  or the [CENTRE] navigation key.
2. Select " Setting Handset" by pressing the arrow keys, and then press .
3. Press [▲] or [▼] to select "Bluetooth Option", and then press .
4. Press [▲] or [▼] to select "Cell Phone", and then press .
5. Press [▲] or [▼] to select "Phonebook", and then press .

6. Press **OK**.
7. Press **[▲]** or **[▼]** to select "2:Other Cell", and then press **OK**.
8. When "Transfer Phonebook From Cell Phone" is displayed, start the transfer by operating the cell phone.

Note

- For details about registering a cell phone, see "Registering and Deregistering a Cell Phone for Phonebook Transfer (Page 35)".
- Phonebook transfer and the Bluetooth headset functions cannot be operated at the same time.
- If a call is received during a transfer, only the phonebook data transferred before the call was received is saved to the handset phonebook.
- If the transfer was not fully completed, "Completed" is displayed, and details of what was not transferred will be shown.
- If the phonebook is locked, the temporary unlocking screen will be displayed, and you will need to temporarily unlock to continue. For details, see "Unlocking the Phonebook Temporarily (Page 38)".
- While transferring phonebook data from a cell phone using Bluetooth, the Bluetooth pictograph will not be displayed on the screen of the handset (see "Display (Page 19)").

- Phonebook names can contain up to 24 characters. Names over 24 characters in length will be shortened to 24 characters when transferred. Note that if extended characters are used, the length of the name transferred may be further reduced.

Transferring vCard Data using Bluetooth



vCard™ is a standard file format for an electronic business card. A vCard can include a name and phone numbers. You can save this vCard data to the handset using Bluetooth wireless transmission.

Note

- Only version 2.1 of vCard is supported.
- If both the name and phone number of a phonebook item being transferred corresponds with existing data in the handset, the phonebook item will not be transferred. Also, phonebook entries without any phone numbers entered will not be transferred to the handset.
- If multiple phone numbers exist for one name item, only the first 6 phone numbers received will be saved. Any numbers beyond the first 6 received will not be saved to the handset.
- Phone numbers that contain more than 32 digits will not be saved to the handset.

Assigning Hot Keys

You can assign a phone number stored in the phonebook to a key to be used as a Hot Key.



1. In standby mode, press and hold a dial key (0–9) for more than 1 second.
2. Press .
3. Press **[▲]** or **[▼]** to select "Copy from P.book", and then press **OK**.
4. Press **[▲]** or **[▼]** to select an entry, or press  to search for an entry, and then press **OK**.
5. Press **[▲]** or **[▼]** to select a number, and then press **OK**.
6. Press **OK**.

Note

- For details about searching for an item in the phonebook, see "Searching for an Item in the Phonebook (Page 28)".

Selecting the Type of Hot Key Dialling

You can select one of 2 types of Hot Key Dialling for each assigned Hot Key.

1. In standby mode, press and hold a dial key (0–9) for more than 1 second.
2. Press .
3. Press **[▲]** or **[▼]** to select "Automatic Call", and then press **OK**.
4. Select "Manual" or "Auto", and then press **OK**.
 - **Manual**: Pressing and holding an assigned Hot Key for the set number of seconds will display the Hot Key's information. Then, press  to dial the Hot Key's assigned number. Alternately, when the Hot Key's information is displayed, you can press **FLEX** and select a DN key to dial using the line assigned to the DN key.
 - **Auto**: Pressing and holding an assigned Hot Key for the set number of seconds will dial that Hot Key's assigned number immediately.

Note

- To select the number of seconds before the call is automatically made, see "Key Option (Page 49)".



Memo Alarm Setting

An alarm will sound at the set time. A memo can also be displayed. Memo Alarm is available only when the handset is within range of a CS.

Note

- You can select the ringer pattern and LED pattern for each Memo Alarm. For details, see "Incoming Option (Page 46)".
- If you are on a call at the time that the alarm is set to sound, it will sound after you have ended the call.

Setting a Memo Alarm

1. Press  or the **[CENTRE]** navigation key.
2. Select " Memo Alarm" by pressing the arrow keys, and then press **OK**.
3. Press **[▲]** or **[▼]** to select an alarm number (1–3), and then press **OK**.
4. Press **[▲]** or **[▼]** to select an alarm mode, and then press **OK**.

The alarm modes are as follows:

- **off**: Disables the selected Memo Alarm.
 - **Once**: The selected Memo Alarm will occur only once.
 - **Daily**: The selected Memo Alarm will occur at the same time every day.
 - **Weekly**: The selected Memo Alarm will occur at the same time on selected days of the week.
5. Set the time and date for the Memo Alarm. The information to enter depends on the alarm mode.
 - **Once**: Enter the date and time, using the Navigator Keys and/or dial keys, and then press **OK**.
 - **Daily**: Enter the daily time, using the Navigator Keys and/or dial keys, and then press **OK**.
 - **Weekly**:
 - a. Press **[▲]** or **[▼]** to select a day of the week, and then press . A ✓ mark will be displayed next to each day of the week that has been selected. In this way, you can select multiple days of the week.
 - b. After selecting 1 or more days of the week, press **OK**.

- c. Enter a time of day using the Navigator Keys and/or dial keys, and then press **OK**.
6. Enter a text message to be displayed when the Memo Alarm occurs, and then press **OK**.
7. Press **OK**.

Note

- For details about entering characters, see "Entering Characters (Page 42)".
- When entering a time of day, press **AM/PM** to toggle between AM or PM. **AM/PM** will not be displayed if 24-hour-time display is set.

Deleting a Memo Alarm

1. Press **☰** or the **[CENTRE]** navigation key.
2. Select "**Memo Alarm**" by pressing the arrow keys, and then press **OK**.
3. Press **[▲]** or **[▼]** to select an alarm number (1–3), and then press **✕**.
4. Press **[▲]** or **[▼]** to select "**Yes**", and then press **OK**.

Stopping a Memo Alarm

- While the alarm is ringing, press **📞**, **🔄C**, **📵**, or set the handset on the charger.

Entering Characters

You can enter characters and digits using the dial keys.

You can select one of 5 character modes by pressing the **Right Soft Key** while entering a name. The function icon above the soft key displays the current character mode. For a list of available characters, see "Character Mode Table (Page 43)".

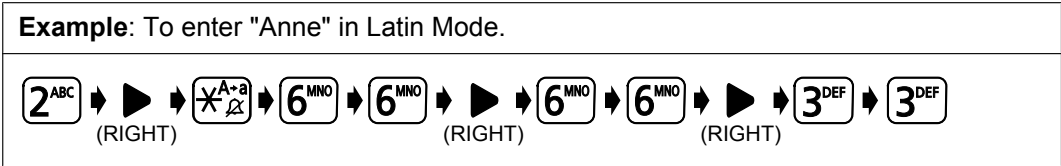
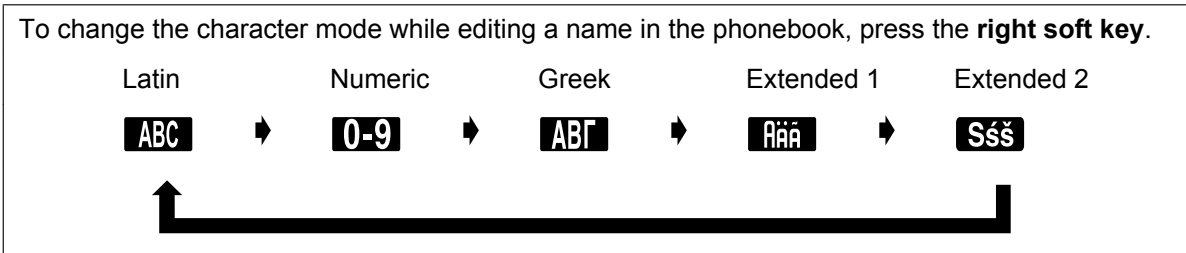
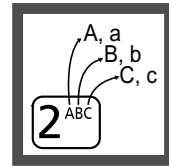

- To switch between uppercase and lowercase, press .
- To enter a character located on the same dialling key as the previous character, move the cursor by pressing the Navigator Key [▶], then enter the desired character.
- If you enter a different character by mistake, press the Navigator Key [◀] or [▶] to highlight the character, press to delete it, and then enter the correct character.
- To clear an entire line, press for more than 1 second.
- To move the cursor, press the Navigator Key [◀], [▶], [▲] or [▼].





Character Mode Table

Keys	ABC (Latin)	0-9 (Numeric)	ABΓ (Greek)	AÄÅ (Extended 1)	SŠŠ (Extended 2)
1	Space # & ' () * , - . / 1	1	Space # & ' () * , - . / 1		
2^{ABC}	ABC 2	2	ΑΒΓ 2	ÄÅÄÄÄÄ ÆBCÇ 2	ÄÅÄÄÅΒCČČ 2
	abc 2		αβγ 2	äåääää æbcç 2	äåääåḄbcčč 2
3^{DEF}	DEF 3	3	ΔΕΖ 3	ÐËÊËËËËË 3	ÐĎËËËËËË 3
	def 3		δεζ 3	dðeèèèèè 3	dďeéééěf 3
4^{GHI}	GHI 4	4	ΗΘΙ 4	ĞĦIIİİİİİİ 4	GHIÍ 4
	ghi 4		ηθι 4	ğĥiııııııııı 4	ghıí 4
5^{JKL}	JKL 5	5	ΚΛΜ 5	JKL 5	JKLŁŁŁ 5
	jkl 5		κλμ 5	jkl 5	jkłłł 5
6^{MNO}	MNO 6	6	ΝΞΟ 6	MNŃOŃŃŃŃ ŎŎøœ 6	MNŃŃŃŃŃŃŃŃ ŎŎ 6
	mno 6		νξο 6	mñňoňňňňňň øœ 6	mñňňňňňňňňňňň
7^{PQRS}	PQRS 7	7	ΠΡΣ 7	PQRSSŞß 7	PQRŘŔSŠŠ 7
	pqrs 7		πρσ 7	pqrsşß 7	pqrřřššš 7
8^{TUV}	TUV 8	8	ΤΥΦ 8	TUÚÚÚÚÚÚV 8	TŤŤUÚÚÚÚV 8
	tuv 8		τυφ 8	tuúúúúúúv 8	tťťuúúúúv 8
9^{WXYZ}	WXYZ 9	9	ΧΨΩ 9	WŴXYŶZ 9	WXYZŶŶZŽŽŽ 9
	wxyz 9		χψω 9	wŵxyŷz 9	wxyŷŷzžžž 9
0	Space ! ? " : ; + = < > 0	0	Space ! ? " : ; + = < > 0		
#	\$ % & @ € £	#	\$ % & @ € £		

- Press **X^{A-a}** before or after entering a character to change between uppercase and lowercase.
- Pressing a key repeatedly will cycle through the characters associated with that key. For example, to enter the letter "C" in Latin Mode, press **2^{ABC}** 3 times.
- Characters that are entered using the # key (for example, "\$") cannot be entered when searching the phonebook. See "Searching for an Item in the Phonebook (Page 28)".
- The illustrations of the keys in the table may differ in appearance from the actual keys on the handset.

Deleting Stored Items



Phonebook

1. Press [▶] or  to display the phonebook.
2. Press [▲] or [▼] to select an item, or press  to search for an item.
3. Press .
4. Press [▲] or [▼] to select "Delete", and then press .
5. Press [▲] or [▼] to select "Yes", and then press .

Note

- In step 4, you can select "Delete All" instead to delete all items.
- For details about searching for an item in the phonebook, see "Searching for an Item in the Phonebook (Page 28)".



Hot Key Dial

1. Press and hold the dialling key assigned as a Hot Key for more than 1 second.
2. Press .
3. Press [▲] or [▼] to select "Delete", and then press .
4. Press [▲] or [▼] to select "Yes", and then press .

Note

- In step 1 while the Hot Key's information is displayed, you can press [▲] or [▼] to select another Hot Key number.
- In step 3, you can select "Delete All" instead to delete all items.

Incoming/Outgoing Call Log

1. In standby mode, press [◀] to open the Incoming Call Log or press [▼] to open the Outgoing Call Log.
2. Select an item stored in the call log, and then press .
3. Press [▲] or [▼] to select "Delete", and then press .
4. Press [▲] or [▼] to select "Yes", and then press .

Note

- In step 3, you can select "Delete All" instead to delete all items.

Changing Handset Settings

Handset Setting Menu Layout

	[Main Item]	[Sub Item]
Setting Handset	├ Incoming Option	├ Ringer Volume
		├ Ringer Type
		├ Vibrate
		├ Ring On Charger
		├ Memo Alarm
		├ Power Save
		└ Headset Ringer
	├ Talk Option	├ Speaker Volume
		├ Receiver Volume
		├ Headset Volume
		├ Headset Mic Vol
		└ Talk On Charger
	├ Answer Option	├ Any Key Answer
		├ Quick Answer
		└ Auto Ans Delay
	├ Key Option	├ Soft Key Edit
		├ Soft Key Name
		├ Key Lock Type
		├ Auto Lock Time
		└ Hot Key Time
	├ Display Option	├ Language
		├ Backlight
		├ LCD Brightness
		├ Standby Display
		├ Category Name
		├ Date Format
		├ Time Format
		├ Caller ID Disp
		└ Colour Scheme

- └ Tone Option
 - └ Key Tone
 - └ Range Alarm
- └ System Option
 - └ Register H/S
 - └ Cancel Base
 - └ Select Base
 - └ System Lock
 - └ Change PIN
 - └ H/S Information
 - └ CS Version
 - └ Firmware Update^{*1}
 - └ Enable CS Web^{*1}
- └ Bluetooth Option
 - └ On/Off
 - └ Cell Phone
 - └ BT Headset
- └ Other Option
 - └ Change Password
 - └ Reset Handset
 - └ MasterCS Address

^{*1} These settings are made available through Web user interface programming. For details, consult your administrator or dealer.

Incoming Option

Sub Item	Description	Setting	Default
Ringer Volume	Adjusts the ringer volume.	<input type="checkbox"/> Step Up <input type="checkbox"/> Step Down <input type="checkbox"/> Level 1–6 <input type="checkbox"/> Off	Level 3

Sub Item	Description	Setting	Default
Ringer Type – Default ⁴ – Private Ring (Category 1–9) – Intercom Ring ⁵ – Ext Ring ⁵ – Group Ring ⁵ – Doorphone ⁵	Ringer Pattern Selects the ringtone for each type of call. ¹	<input type="checkbox"/> Ringtone 1–19, 25–32	Ringtone 1
	LED Pattern Selects the LED pattern for each type of call.	<input type="checkbox"/> Red <input type="checkbox"/> Green <input type="checkbox"/> Orange <input type="checkbox"/> R→G→O	Default: Red Private Ring: Green
	Vib. Pattern Selects the vibrate pattern for each type of call.	<input type="checkbox"/> Single <input type="checkbox"/> Double <input type="checkbox"/> Triple <input type="checkbox"/> Continuous	Single
	Colour Pattern² Selects the colour pattern for each type of call.	<input type="checkbox"/> Normal <input type="checkbox"/> Yellow <input type="checkbox"/> Red	Normal
Vibrate	Selects whether the handset vibrates while receiving a call.	<input type="checkbox"/> Vib.& Ring <input type="checkbox"/> Vib.→ Ring <input type="checkbox"/> Off	Off
Ring On Charger	Selects the ringing mode (On or Off) while a handset is set on the charger. ³	<input type="checkbox"/> On <input type="checkbox"/> Off	On
Memo Alarm	Ringer Pattern Selects the ringtone for each Memo Alarm.	<input type="checkbox"/> Ringtone 1–19, 25–32	Ringtone 1
	LED Pattern Selects the LED pattern for each Memo Alarm.	<input type="checkbox"/> Red <input type="checkbox"/> Green <input type="checkbox"/> Orange <input type="checkbox"/> R→G→O	Green
	Vib. Pattern Selects the vibrate pattern for each Memo Alarm.	<input type="checkbox"/> Single <input type="checkbox"/> Double <input type="checkbox"/> Triple <input type="checkbox"/> Continuous	Single

Sub Item	Description	Setting	Default
Power Save	Power Save Time Selects the number of seconds before automatically turning off the Power Save Items below when receiving a call.	0–60 s	30s
	Power Save Item Selects the items to turn off.	<input type="checkbox"/> Ringer&Vibrate <input type="checkbox"/> Backlight	Not selected
Headset Ringer	Selects whether a tone is heard from the attached headset while receiving a call.	<input type="checkbox"/> On <input type="checkbox"/> Off	Off

*1 The preset melodies in this product are used with permission of © 2010 Copyrights Vision Inc.

*2 Displayed only when "Private Ring" is selected.

*3 When "Ring On Charger" is set to "On" but "Ringer Volume" is set to "Off", the handset rings at level 1.

*4 This Ringer Type is available if the CS is connected to the SIP server.

*5 This Ringer Type is available if the CS is connected to a KX-NS1000 PBX.

Talk Option

Sub Item	Description	Setting	Default
Speaker Volume	Adjusts the rear speaker volume.	Level 1–6	Level 3
Receiver Volume	Adjusts the receiver volume.	Level 1–6	Level 2
Headset Volume	Adjusts the headset speaker volume.	Level 1–6	Level 2
Headset Mic Vol	Adjusts the headset microphone volume.	Level 1–6	Level 6
Talk On Charger	Selects whether or not to continue the conversation when the handset is put on the charger during a conversation.	<input type="checkbox"/> On <input type="checkbox"/> Off	Off

Answer Option

Sub Item	Description	Setting	Default
Any Key Answer	Answers a call by pressing any dialling key.	<input type="checkbox"/> On <input type="checkbox"/> Off	Off
Quick Answer	Answers a call while the phone is charging by just lifting up a handset from the charger.	<input type="checkbox"/> On <input type="checkbox"/> Off	Off
Auto Ans Delay	Selects the number of seconds before a call is automatically answered when Auto Answer is turned on.	0–20 s	6s

Key Option

Sub Item	Description	Setting	Default
Soft Key Edit – Softkey A – Softkey B – Softkey C	Edits the soft keys. – Standby – Talking	<input type="checkbox"/> Default <input type="checkbox"/> Flexible Key <input type="checkbox"/> Function Key <input type="checkbox"/> Hot Key Dial ¹	Not stored
Soft Key Name – Softkey A – Softkey B – Softkey C	Edits the names of the soft keys. – Standby – Talking	Max. 5 characters	Not stored
Key Lock Type	Selects the type of key lock.	<input type="checkbox"/> Manual <input type="checkbox"/> Manual&Password ^{2,3} <input type="checkbox"/> Auto <input type="checkbox"/> Auto&Password ^{2,3}	Manual
Auto Lock Time	Sets the number of seconds before the handset key lock is activated when "Auto" is selected as the Key Lock Type.	0–60 s	10s
Hot Key Time	Selects the number of seconds before a call is automatically made when a Hot Key assigned to "Auto" is pressed and held.	1–20 s	2s

¹ Displayed only when "standby" is selected.

² To avoid unauthorised access to this product:

- Set a password that is random and cannot be easily guessed.
- Change the password regularly.

³ If no password has been set, you cannot select "Manual&Password" or "Auto&Password" for "Key Lock Type". For details about setting the password, see "Setting the Password (Page 17)".

Display Option

Sub Item	Description	Setting	Default
Language	Selects the display language.	<input type="checkbox"/> Deutsch <input type="checkbox"/> English <input type="checkbox"/> Español <input type="checkbox"/> FRANÇAIS <input type="checkbox"/> Italiano <input type="checkbox"/> Dansk <input type="checkbox"/> Nederlands <input type="checkbox"/> Svenska <input type="checkbox"/> ΕΛΛΗΝΙΚΑ <input type="checkbox"/> Magyar <input type="checkbox"/> Português <input type="checkbox"/> Polski <input type="checkbox"/> slovensky <input type="checkbox"/> Čeština <input type="checkbox"/> Hrvatski	English
Backlight	Turns on the backlight of the LCD and keypad. Can be set for each of the following: <ul style="list-style-type: none"> – Receiving – Talking 	<input type="checkbox"/> On <input type="checkbox"/> Off	Receiving: Off Talking: On
LCD Brightness	Adjusts the brightness of the backlight of the LCD.	Level 1–6	Level 3
Standby Display	Selects what is shown on the display while in standby mode. ¹	<input type="checkbox"/> Handset Number <input type="checkbox"/> Base & H/S No. <input type="checkbox"/> Edit <input type="checkbox"/> Off	Handset Number
	Edits the name displayed on the LCD while in standby mode.	Max. 16 characters	Not stored
Category Name	Edits the names of the categories.	Max. 13 characters per Category (1–9)	Not stored
Date Format	Selects the format for the date shown on the display.	<input type="checkbox"/> DD-MM-YYYY <input type="checkbox"/> MM-DD-YYYY <input type="checkbox"/> YYYY-MM-DD	DD-MM-YYYY
Time Format	Selects the format for the time shown on the display.	<input type="checkbox"/> 12H <input type="checkbox"/> 24H	24H

Sub Item	Description	Setting	Default
Caller ID Disp	Selects which caller information is displayed when a call is received. Either the information stored in the handset's phonebook or the phone system can be displayed.	<input type="checkbox"/> H/S Phonebook <input type="checkbox"/> PBX Setting	PBX Setting
Colour Scheme	Selects the colour scheme of the LCD.	<input type="checkbox"/> Dark <input type="checkbox"/> Light	Dark

^{*1} If an extension name is assigned through Web user interface programming, the extension name is displayed when "Handset Number" or "Base & H/S No." is selected. Depending on the number of characters stored for the extension name, the end of the extension name may not be displayed.

Tone Option

Sub Item	Description	Setting	Default
Key Tone	Turns the key tone on or off.	<input type="checkbox"/> On <input type="checkbox"/> Off	On
Range Alarm	Selects whether the range alarm tone rings or not.	<input type="checkbox"/> On <input type="checkbox"/> Off	On

System Option

Sub Item	Description	Setting	Default
Register H/S	Registers a handset to a base.	Base 1–4	Not stored
Cancel Base ^{*1}	Cancels the registration of a handset.	Base 1–4 ²	Not selected
Select Base ^{*1}	Selects a base.	<input type="checkbox"/> Auto <input type="checkbox"/> Base 1–4	Auto
System Lock	Selects whether to lock the System Option setting or not.	<input type="checkbox"/> On ³ <input type="checkbox"/> Off	Off
Change PIN	Before registering your handset with a phone system, enter the phone system's PIN here. Once you have registered the handset with a phone system, this PIN can be changed so that the handset can be registered to an additional phone system.	Enter the PIN number. (max. 8 digits)	1234
H/S Information	Displays the firmware version and the IPEI (International Portable Equipment Identity) number of the handset.	—	—

Customising the Telephone

Sub Item	Description	Setting	Default
CS Version	Displays the firmware version and the IPL (Initial Program Loader) number of the CS that the handset is registered to.	—	—

*1 Only registered bases are shown.

*2 You can select multiple bases simultaneously.

*3 Password is required (4 digits). For details about setting the password, see "Setting the Password (Page 17)".

Bluetooth Option

Sub Item	Description	Setting	Default
On/Off	Turns the Bluetooth function on or off.	<input type="checkbox"/> On <input type="checkbox"/> Off	Off
Cell Phone	Phonebook Receives the phonebook from a cell phone by Bluetooth.	—	—
	Registration Registers or deregisters a cell phone.	<input type="checkbox"/> Register <input type="checkbox"/> Deregister	Not registered
	Change BT PIN Sets or changes the Bluetooth PIN number.	Enter the PIN Code. (4 digits)	Not registered
BT Headset	Connection *1 Connects or disconnects a Bluetooth headset.	<input type="checkbox"/> On <input type="checkbox"/> Off	On
	Registration Registers or deregisters a Bluetooth headset.	<input type="checkbox"/> Register <input type="checkbox"/> Deregister	Not registered
	Headset Mic Vol Adjusts the microphone volume of the Bluetooth headset.	Level 1–6	Level 3

*1 If a Bluetooth headset has not been registered yet, the "Registration" screen of "BT Headset" is displayed when this option is selected.

Other Option

Sub Item	Description	Setting	Default
Change Password *1*2	Changes the handset password (4 digits) used for unlocking the phonebook, using the Reset Handset option, and unlocking the key lock.	Enter Old Password.*3 ↓ Enter New Password. ↓ Verify New Password.	Not registered

Sub Item	Description	Setting	Default
Reset Handset	Returns the handset settings to its default settings.	Enter Password. ⁴ (4 digits) ↓ Select the desired item(s). ↓ Press OK .	Not selected
MasterCS Address	Displays the IP address of the Master CS. If the handset is not yet registered, "xxx . xxx . xxx . xxx" will be displayed.	—	—

- ¹ To avoid unauthorised access to this product:
- Set a password that is random and cannot be easily guessed.
 - Change the password regularly.
- ² Make a note of the password so that you will not forget it.
- ³ If a password has not already been set, you can skip the first step.
- ⁴ For details about setting the password, see "Setting the Password (Page 17)".

Installation and Setup

Battery Installation

Open the battery cover, insert the battery, and close the cover as indicated below.

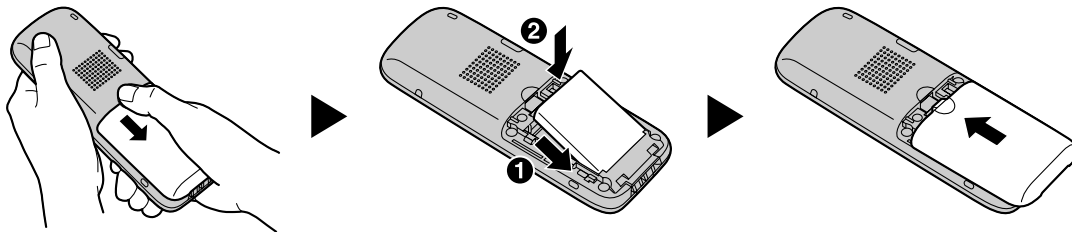

Charger Connection

Connect the AC adaptor to the charger.

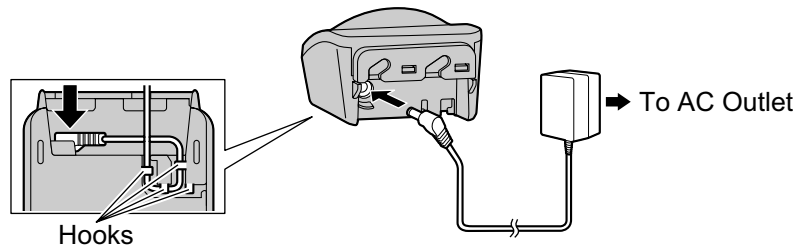

- The AC adaptor should be connected to a vertically oriented or floor-mounted AC outlet. Do not connect the AC adaptor to a ceiling-mounted AC outlet, as the weight of the adaptor may cause it to become disconnected.
- Fasten the AC adaptor cord to the cord holder.
- Use only the included Panasonic AC adaptor. For details, see "Accessory Information (Page 14)".

WARNING

- To reduce the risk of fire or electric shock, do not overload AC outlets and extension cords.
- Do not bundle the charger's AC adaptor cord with the power cords of machines located nearby.
- Completely insert the AC adaptor/power plug into the AC outlet. Failure to do so may cause electric shock and/or excessive heat resulting in a fire.
- Regularly remove any dust, etc. from the AC adaptor/power plug by pulling it from the power outlet, then wiping with a dry cloth. Accumulated dust may cause an insulation defect from moisture, etc. resulting in a fire.

Charging the Battery

At the time of shipment, the battery is not charged. **Please charge the battery for about 3 hours before using the handset for the first time.**

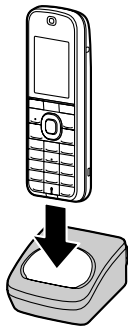

- The charge indicator will turn off when the battery is fully charged. For more information about charging the battery, see "Battery Information (Page 12)".
- It is normal for the handset and charger to feel warm while the battery is charging.
- Keep devices sensitive to magnetic fields away from the charger.
- Use only the included charger.

Charger Wall Mounting

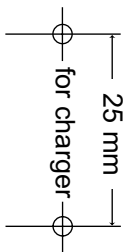

1. Install the two screws in the wall, spacing them 25 mm apart.

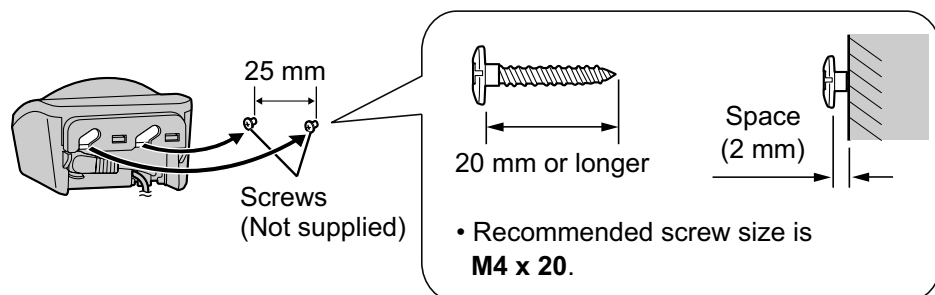

2. Mount the charger securely on the wall.

- Please copy this page and use as a reference for wall mounting. Make sure to set the print size to correspond with the size of this page. If the dimension of the paper output still deviates slightly from the measurement indicated here, use the measurement indicated here.
- When mounting the charger, ensure that the correct screws are used for the type of wall.
- Make sure that the wall that the charger will be attached to is strong enough to support the total weight of the handset and charger (approx. 135 g). If not, it is necessary for the wall to be reinforced.
- When this product is no longer in use, make sure to detach it from the wall.
- When inserting screws, avoid pipes and electrical cables, etc, that may be present/buried.
- The screw heads should not be flush to the wall.
- Certain types of wall may require plugs to be anchored in the wall before the screws are inserted.

Attaching the Belt Clip

You can attach the handset to your belt by following the steps below.

[To attach]

1. Insert the clip into the designated notches in the handset.
2. Slide the clip into the holder until it clicks.

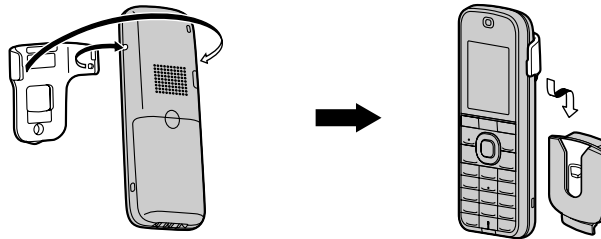

[To remove]

1. Make sure to turn the handset 180° when you take it off.
2. Remove the belt clip.

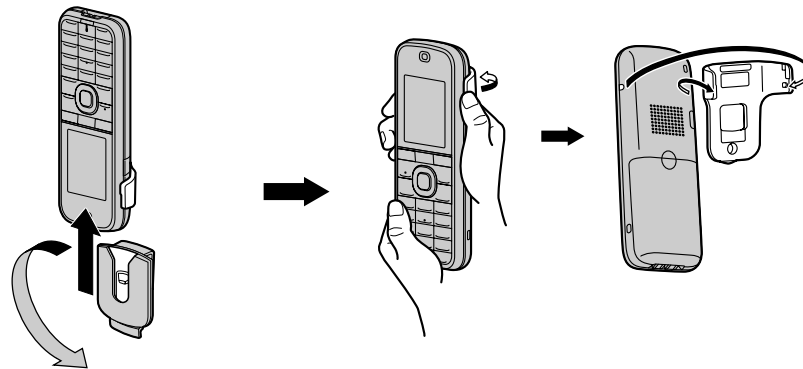

Attaching the Phone Strap

Open the battery cover, run the strap through the strap hole, and then loop it around the hook.

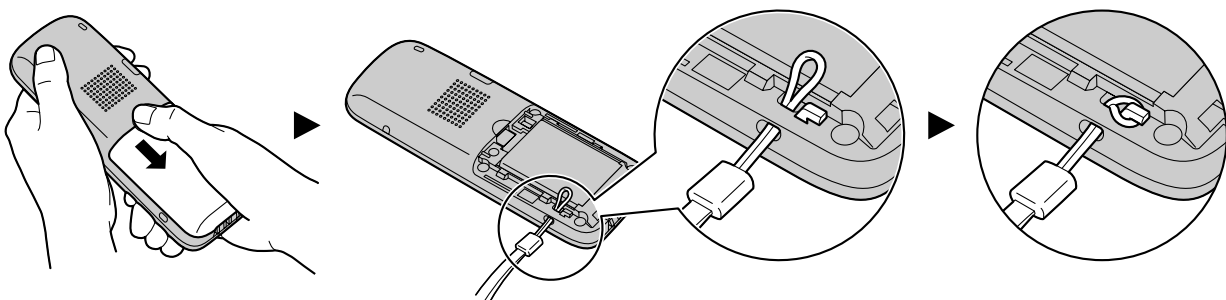

Appendix

Specifications

Item	Specifications
Display	1.8-inch TFT Backlight LCD, 65,000 colours
Headset Jack	1 (ø 2.5 mm)
Battery	Li-Ion 3.7 V (700 mAh)
Maximum Power Consumption (Charger)	Standby: 0.3 W Maximum: 4.0 W
Battery Performance	Talk: up to 13 hours Standby: up to 200 hours
Charging Time	3 hours
Dimensions (Width × Depth × Height)	Handset only: 48.5 mm × 17.9 mm × 127.5 mm Handset on charger: 63.0 mm × 78.0 mm × 140.0 mm
Weight	Handset (including battery): 88 g Handset (including battery) and charger: 135 g
Operating Environment	0 °C to 40 °C 5 °C to 40 °C (When charging)



RF Specifications (DECT)

Item	Specifications
Frequency Band	1880 MHz to 1900 MHz
Number of Carriers	10
Transmission Output	Average 10 mW Peak 250 mW

RF Specifications (Bluetooth)

Item	Specifications
Frequency Band	2.4000 GHz to 2.4835 GHz
Class	Class 2

Troubleshooting

Problem	Possible Cause	Solution
The handset does not work.	The battery is drained.	Charge the battery fully. For details, see "Charging the Battery (Page 55)".
	The power is off.	<ul style="list-style-type: none"> Turn it on. For details, see "Location of Controls (Page 15)". Re-insert the battery, and then set the handset on the charger. For details, see "Battery Installation (Page 54)", and "Charging the Battery (Page 55)".
The handset does not ring.	Ringer volume is set to "OFF". (If the ringer volume is set to "OFF",  is displayed.)	Adjust the ringer volume level. For details, see "Adjusting the Ringer Volume (Page 25)".
	Silent Mode is on. (If Silent Mode is on, the  icon is displayed.)	Turn off Silent Mode. For details, see "Silent Mode (Page 17)".
It is difficult to have a conversation when in Hands-free mode.	The microphone is facing the wrong direction or is obstructed during the conversation.	The front of the handset should face you, and the microphone should not be covered. For details, see "Location of Controls (Page 15)".
You cannot make/receive a call.	The handset is out of range, or the CS is busy.	Move closer to the CS or try again later.
	The radio channel is busy, or a radio communication error occurred.	Try again later.
You cannot dial.	The number that you dialed is restricted by your phone system.	Consult your administrator or dealer.
	Key lock mode is on.	To cancel the mode, press and hold  for about 2 seconds. For details, see "Key Lock (Page 17)".
	The radio channel is busy or a radio communication error occurred.	Try again later.
The handset stops working during operation.	An unknown error has occurred.	<ul style="list-style-type: none"> Turn the handset off, and then turn it back on. For details, see "Location of Controls (Page 15)". Re-insert the battery and try again. For details, see "Battery Installation (Page 54)".

Problem	Possible Cause	Solution
You cannot use the handset during a power failure.	The handset will not function during a power failure because the CS stops emitting radio waves.	—
The headset does not work.	The headset ringer cannot be heard when receiving an incoming call when the headset is attached.	<ul style="list-style-type: none"> • Make sure the headset ringer setting is set to "on". For details, see "Incoming Option (Page 46)". • Make sure the headset jack is connected properly. For details, see "Location of Controls (Page 15)".
The tone from the Bluetooth headset cannot be changed.	The Bluetooth headset tone is a specific tone and is not related to the Incoming Option settings (Ringer Type).	—
Noise is frequently heard.	Nearby electrical appliances are causing interference, or you are too far from the CS.	<ul style="list-style-type: none"> • Place the handset and CS away from other electrical appliances. • Move closer to the CS.
Two short beeps are heard during a conversation.	The radio signal is weak.	Move closer to the CS.
You charged the battery for 3 hours, but the beep tones sound, and  flashes (needs to be charged) after a few telephone calls.	The battery charge contacts may be dirty.	Clean the battery charge contacts without damaging them and charge once more.
	It is time to change the battery.	Replace with a new battery.
While charging the battery, the handset and the AC adaptor feel warm.	These are normal conditions.	—
"No Service" is displayed, and beep tones are heard.	The handset is out of range.	Move closer to the CS or try again later.
	The CS or phone service is out of service.	Consult your administrator or dealer.
While charging the battery, the LED indicator blinks rapidly, but the handset does not beep.	The temperature of the battery being charged is outside of normal limits.	Confirm that the area where the handset is being charged is between 5 °C and 40 °C, and wait for the battery's temperature to drop.

Problem	Possible Cause	Solution
<p>While charging the battery, the LED indicator blinks rapidly and the handset beeps rapidly.</p>	<p>The battery is not charging correctly due to an electrical failure.</p>	<p>Unplug the AC adaptor from the AC outlet, remove the battery from the handset, and consult your dealer.</p>
<p>I cannot copy the phonebook entries from my cell phone.</p>	<p>The cell phone does not support the Bluetooth function.</p>	<ul style="list-style-type: none"> • Confirm that the cell phone supports Bluetooth wireless technology. • Confirm that the cell phone supports the Object Push Profile (OPP) or Phone Book Access Profile (PBAP) specification.
	<p>A connection error has occurred.</p>	<ul style="list-style-type: none"> • If the cell phone is already connected to another Bluetooth device such as a Bluetooth headset, turn it off or disconnect it from the cell phone. • Turn the cell phone off, and then turn it on and try again.
<p>I cannot have a conversation using a Bluetooth headset.</p>	<p>The Bluetooth headset is not registered to the handset.</p>	<p>Register the Bluetooth headset to the handset. For details, see "Registering a Bluetooth Headset (Page 33)".</p>
	<p>A connection error has occurred.</p>	<p>Turn the Bluetooth headset off, and then turn it on and try again.</p>
	<p>A wired headset is also connected to the handset.</p>	<p>Disconnect the wired headset from the handset, and try again.</p>
	<p>The Bluetooth headset is out of range of the handset.</p>	<p>The Bluetooth headset can communicate within a certain range of the handset. The connection may be subject to interference from obstructions such as walls or electronic devices. Move closer to the handset, and try again.</p>
<p>Noise is heard during a call on the Bluetooth headset.</p>	<p>The Bluetooth headset is too far away from the handset.</p>	<p>The Bluetooth headset can communicate within a certain range of the handset. The connection may be subject to interference from obstructions such as walls or electronic devices. Move closer to the handset.</p>

Problem	Possible Cause	Solution
I cannot connect a Bluetooth headset to the handset.	The Bluetooth headset or the Bluetooth function of the handset is off.	<ul style="list-style-type: none"> • Confirm that the Bluetooth headset is turned on. • Confirm that the Bluetooth setting of the handset is turned on. For details, see "Turning Bluetooth On or Off (Page 32)".
	A connection or registration error has occurred.	<ul style="list-style-type: none"> • If the Bluetooth headset is already registered to another Bluetooth device such as a cell phone, disconnect the Bluetooth headset from the cell phone, and then perform the connection procedure from the handset. • The Bluetooth headset is not registered to the handset. Register the Bluetooth headset. For details, see "Registering a Bluetooth Headset (Page 33)".
Some headset features are not functioning.	The handset does not support enhanced features such as last number redial or call reject.	—
An error tone is heard when I try to connect a Bluetooth device to the handset.	The Bluetooth function is not ready.	<ul style="list-style-type: none"> • The Bluetooth function cannot be accessed immediately after turning on the handset. Wait a few seconds and try again. • A connection could not be made between the handset and the Bluetooth device. Wait a few seconds and try again.
I cannot remember the PIN number.	—	Consult your administrator or dealer.
The "Delete All" operation to delete all phonebook entries is not functioning.	The battery is drained, which prevents the operation from being completed.	Charge the battery fully, then try again. For details, see "Charging the Battery (Page 55)".
The System Speed Dial Download of the KX-NS1000 PBX is enabled but some of the phone numbers to be downloaded (default: 100) are not downloaded to the handset phonebook. ¹	The total number of the phone numbers registered to the handset and the phone numbers downloaded from the PBX exceeds the handset phonebook capacity (500 numbers).	Delete the phone numbers of the handset phonebook which were registered manually.

¹ This item is applied only when the CS is connected to a KX-NS1000 PBX.

Error Messages

Error Message	Possible Cause	Solution
Register Unit	The handset has been cancelled or the handset has not been registered.	Consult your dealer.
No Service	The handset is out of range.	Move closer to the CS.
	The CS is turned off.	Make sure the power cord is connected.
CS Busy	The CS is busy.	Try again later.
Charge Battery	The handset battery has little charge remaining.	Charge the battery fully. For details, see "Charging the Battery (Page 55)".
No Entries	When trying to view the phonebook: No items have been stored. For details, see "Storing an Item in the Handset Phonebook (Page 36)". When trying to view the Incoming or Outgoing Call Log: No logs have been stored.	—
Memory Full	The phonebook is full and cannot store the new item.	Remove unnecessary data in the phonebook and try again.
Need Repair	There is an error with the fixed internal memory.	Consult your dealer.
System Locked	The System Option menu has been locked and cannot be accessed.	Consult your administrator or dealer.
Password Not Stored	Displayed when you access a feature that requires a password, but a password has not been set.	Set a password. See "Setting the Password (Page 17)".
Transfer Error	A connection with a cell phone has been interrupted.	Perform the connection procedure with the cell phone again. For details, see "Transferring Phonebook Data from a Cell Phone using Bluetooth (Page 38)".
Register Error	Handset registration has failed or a time-out has occurred.	Wait and try again, or consult your administrator or dealer.
Error	An error message is received from the CS when trying to change FWD/DND status.	Try again, or consult your administrator or dealer.
Aborted	There was a wireless transmission error during a phonebook download or upload.	Use the PS closer to the CS.

Error Message	Possible Cause	Solution
Phonebook Error	There was a wireless transmission error, corrupted data, or the memory became full during a phonebook download.	<ul style="list-style-type: none"> Remove unnecessary data in the phonebook, or consult your administrator regarding the number of items being downloaded. Use the PS closer to the CS.
Download Failed	There was an error during a PS firmware update.	Consult your administrator or dealer.
<ERROR 1>/<ERROR 2>	There was a hardware error during a PS firmware update.	Consult your administrator or dealer.
Connect Error	An error occurred when establishing a Bluetooth headset connection.	Ensure the headset is operating correctly, and then try to establish the connection with the handset again.
Disconnect Error	An error occurred when deregistering a headset that has been registered to the handset.	Ensure the handset and the headset are within range of each other, and then perform the deregistration operation again.
Link Error	An error occurred during a phonebook download.	Ensure the handset and the other device are within range of each other, and then perform the download operation again.
BT Headset Link Error	The Bluetooth headset is out of range of the handset.	When you are using a Bluetooth headset, always keep the handset within range. We recommend keeping the handset and headset within 1 m of each other for best performance.
Completed (Information)	<p>During a phonebook download, some data was not transferred.</p> <ul style="list-style-type: none"> If an entry with the same name already exists in the handset's phonebook, only a total of 6 numbers can be registered to that entry. Once 6 phone numbers have been registered to a name, any additional numbers will not be downloaded. Phone numbers longer than 32 digits in length are not downloaded to the handset's phonebook. 	<ul style="list-style-type: none"> Before downloading, confirm that the source data does not contain more phone numbers than can be downloaded for each name, and does not have any phone numbers greater than 32 digits in length. Check the data downloaded to the handset after the error message is displayed, and edit the phonebook contents as necessary.

Index

A

- AC adaptor 14
- Accessories 14

B

- Battery 14
 - Charging 55
 - Installation 54
- Battery information 12
- Belt clip 14
 - Attaching 56
- Belt clip holder 14
- Bluetooth 32

C

- Call Forwarding 32
- Call Log
 - Deleting 44
 - Making a call 27
 - Storing to phonebook 37
- Call Waiting 32
- Caller ID 29
- Calls
 - Holding 30
 - Making 27
 - Receiving 29
 - Transferring 30
- Category names, editing 38
- Characters
 - Available characters 43
 - Entering 42
- Charger 14
 - Connection 54
 - Wall mounting 55
- Conference 31
- Controls, locations of 15

D

- Display language 25
- Do Not Disturb (DND) 32

E

- Error messages 62

F

- Flexible Keys 22
 - Editing names 25
- Function keys 24
- Function menus 24

H

- Headset volume 26
- Hold 30
- Hot Key

- Assigning 40
- Deleting 44
- Dialling 27

K

- Key Lock 17

L

- Lock
 - Keys 17
 - Phonebook 38

M

- Memo Alarm 40

N

- Noise Reduction 18

O

- One-touch Dialling 27
- Operation outline 23

P

- Phone strap, attaching 56
- Phonebook 36
 - Category names, editing 38
 - Deleting 44
 - Editing 36
 - Locking 38
 - Searching 28
 - Storing from call log 37
 - Storing from predial 37
 - Storing new 36
- Phonebook and vCard by Bluetooth 38
- Power Save Mode 18
- Private Ring 36

R

- Receiver volume 26
- Ringer volume 25

S

- Settings 45
 - Answer Option 48
 - Bluetooth Option 52
 - Display Option 50
 - Incoming Option 46
 - Key Option 49
 - Other Option 52
 - System Option 51
 - Talk Option 48
 - Tone Option 51
- Silent Mode 17
- Soft Keys 20
- Speaker volume 26
- Specifications 57
- Standby display number 25

T

- Text, entering 42
- Three-party conference 31
- Transferring a call 30

V

- Vibrate 25
- Voice Mail 32
- Volume
 - Receiver/Speaker/Headset 26
 - Ringer 25

Panasonic System Networks Co., Ltd.

1-62, 4-chome, Minoshima, Hakata-ku, Fukuoka 812-8531, Japan

<http://panasonic.net/pcc/support/sipphone>

Copyright:

This material is copyrighted by Panasonic System Networks Co., Ltd., and may be reproduced for internal use only. All other reproduction, in whole or in part, is prohibited without the written consent of Panasonic System Networks Co., Ltd.

© Panasonic System Networks Co., Ltd. 2012